



OPEL

Insignia Sedan F69 11/2008-
Insignia Hatchback F68 11/2008-
Insignia Sports Tourer F35 11/2008-

CHEVROLET

Aveo HB MY 2012-
Aveo SDN MY 2012-
Cruze HB MY 2012-
Cruze NB MY 2010-

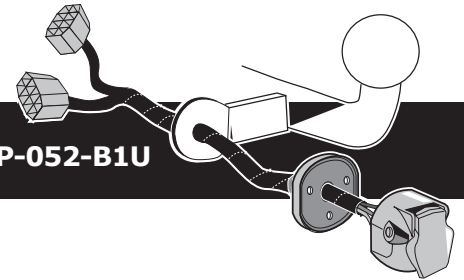

Partnr.: OP-052-B1U

- Fitting instructions electric wiring kit tow bar with 12-N socket up to DIN/ISO Norm 1724.
- We would expressly point out that assembly not carried out properly by a competent installer will result in cancellation of any right to damage compensation, in particular those arising by virtue of the product liability act.
- Contents of these kits and their fitting manuals are subject to alteration without notice, please ensure that these instructions are read and fully understood before commencing installation.
- Do not overload circuits; the maximum loads per connection are detailed in this manual.
- Attention! Before Installation, please read this manual carefully and inform your customer to consult the vehicle owners manual to check for any vehicle modifications required before towing.
- In the event of functional problems, troubleshooting must be limited to about 0.5 hours, contact the technical support:
t.skinner@ecs-electronics.com / 07440 202 052.



Part list

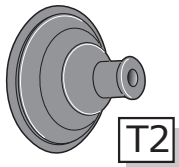
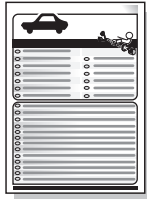
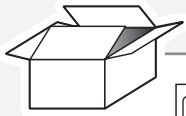

T2



T1

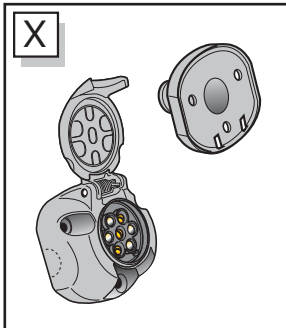

X

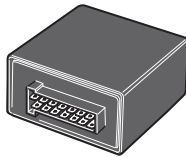

M

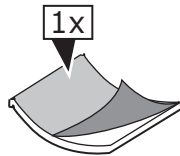

1x



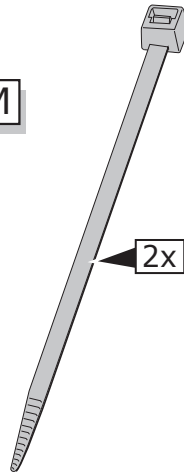

G



2x

UN-243-YZ
 Optional reverse lamp
 pre-wire extension included

Pag. 37

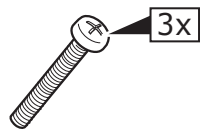

3x

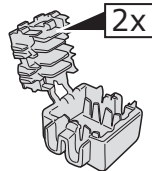

2x



3x

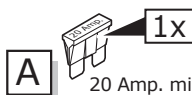

A

20 Amp. minifuse

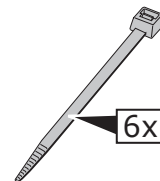

6x

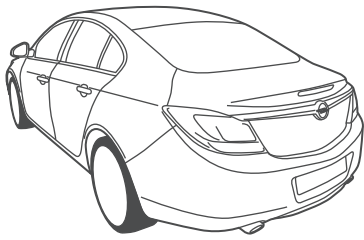

Insignia SD

Pag. 4
-
Pag. 8

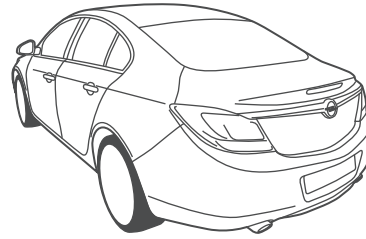

Insignia HB

Pag. 9
-
Pag. 12

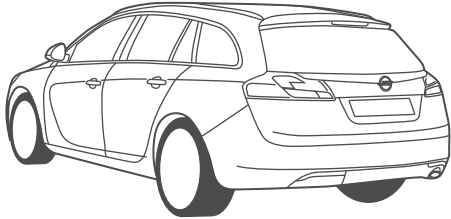

Insignia ST

Pag. 13
-
Pag. 17

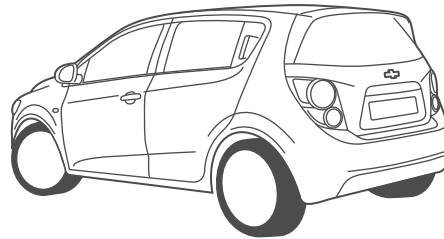

Aveo HB

Pag. 18
-
Pag. 20

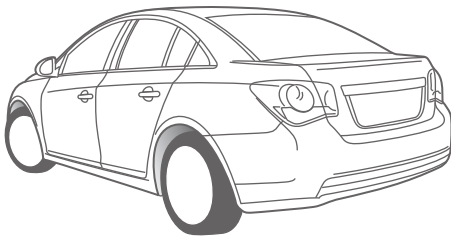

Aveo SD

Pag. 21
-
Pag. 23

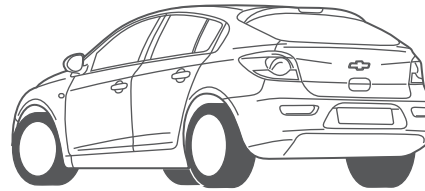

Cruze HB

Pag. 24
-
Pag. 26

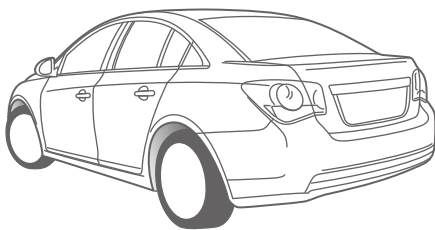

Cruze NB

Pag. 27
-
Pag. 30

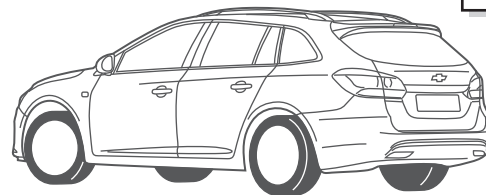

Cruze SW

Pag. 31
-
Pag. 33

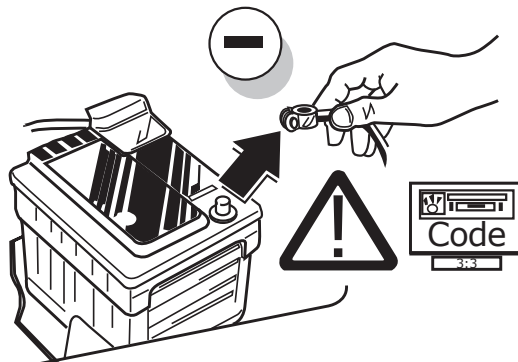

INFO

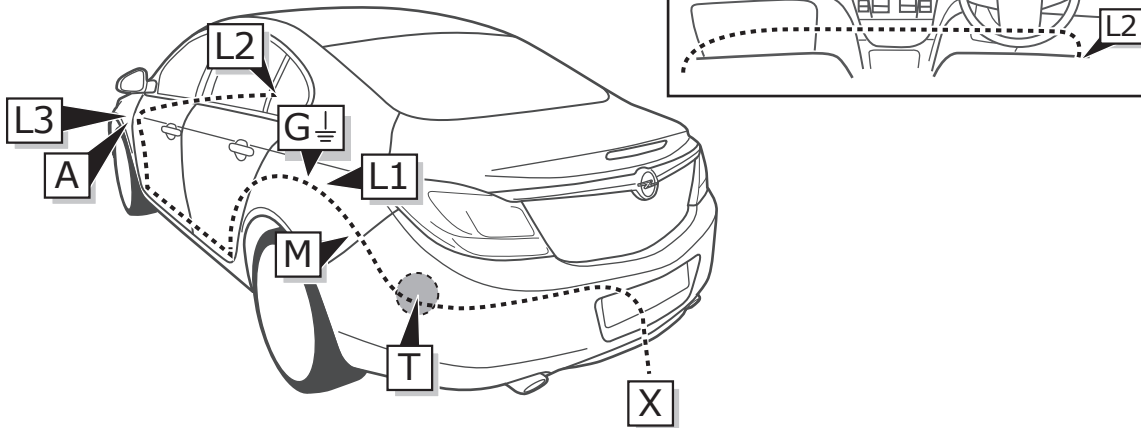

Insignia SD

Pag. 4

-

Pag. 8

1

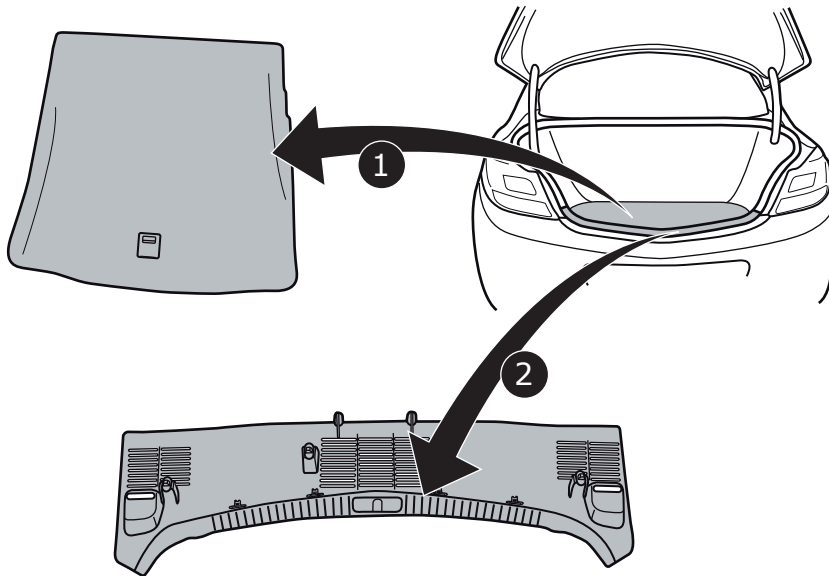

2

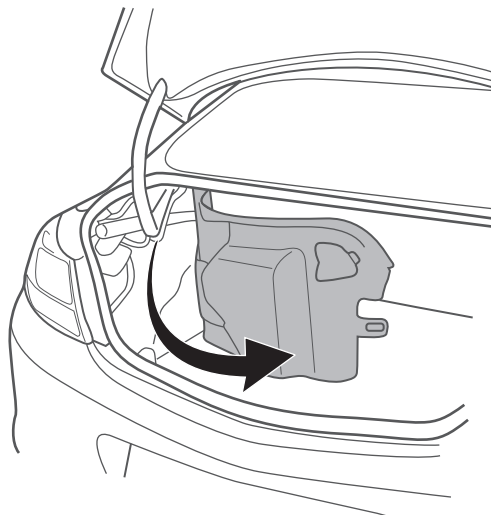

3

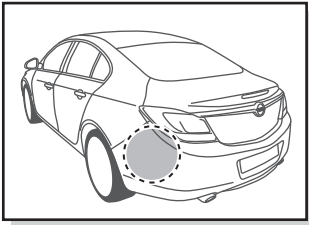
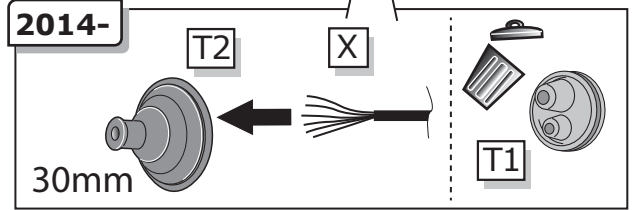
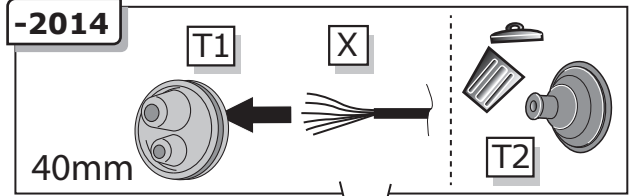
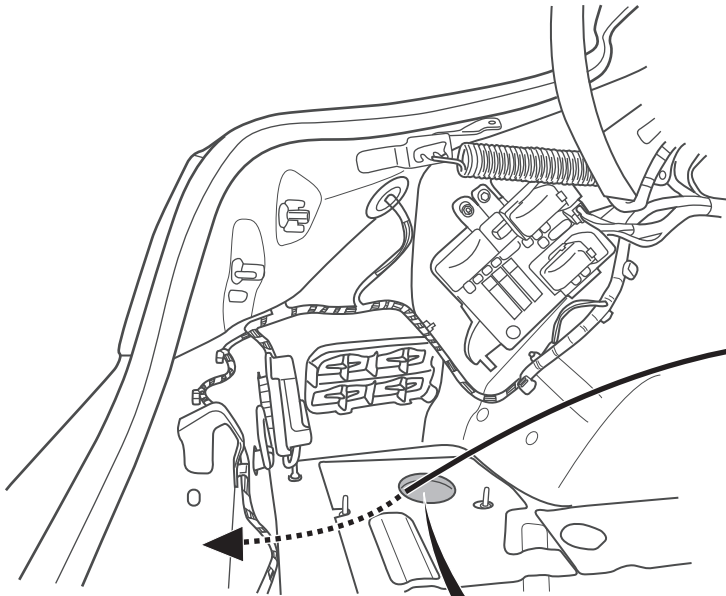

4



5

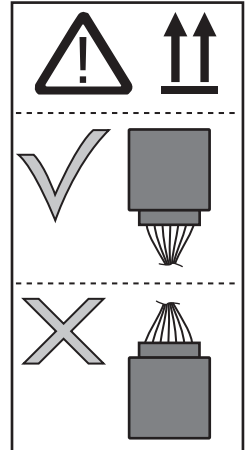
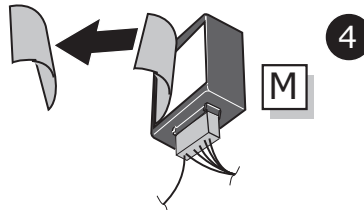
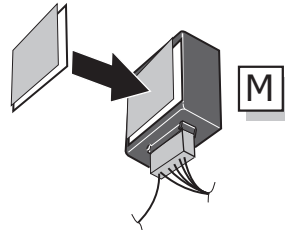
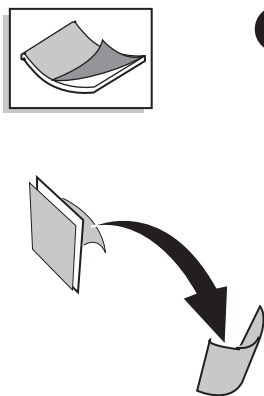
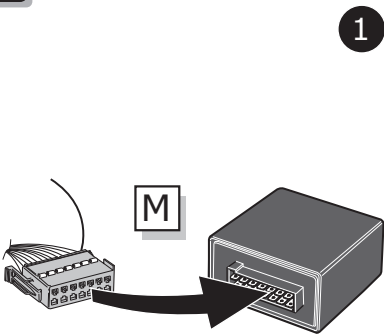

6

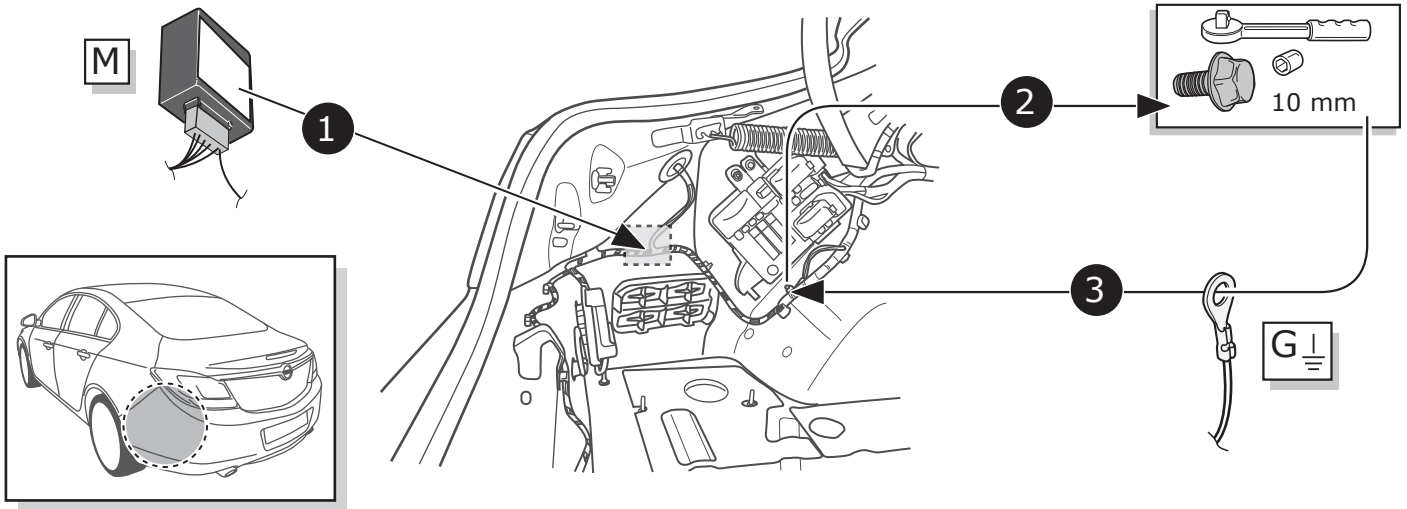

7

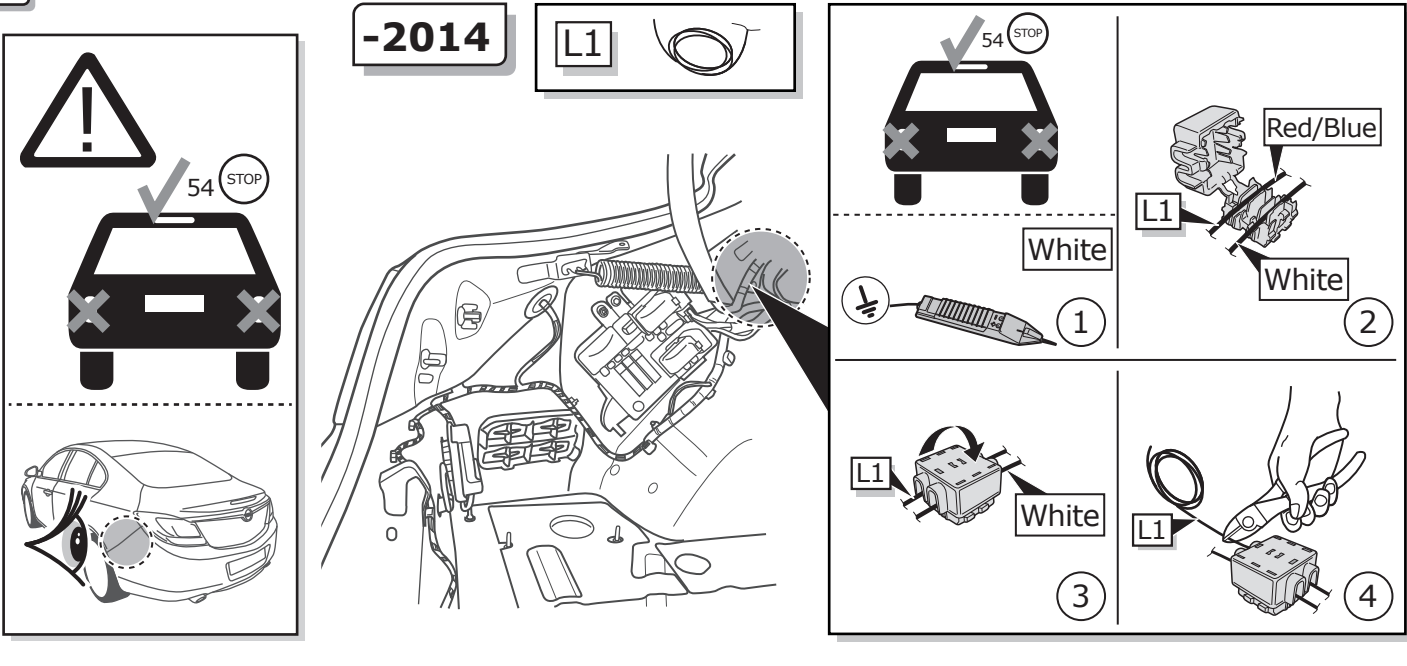

8

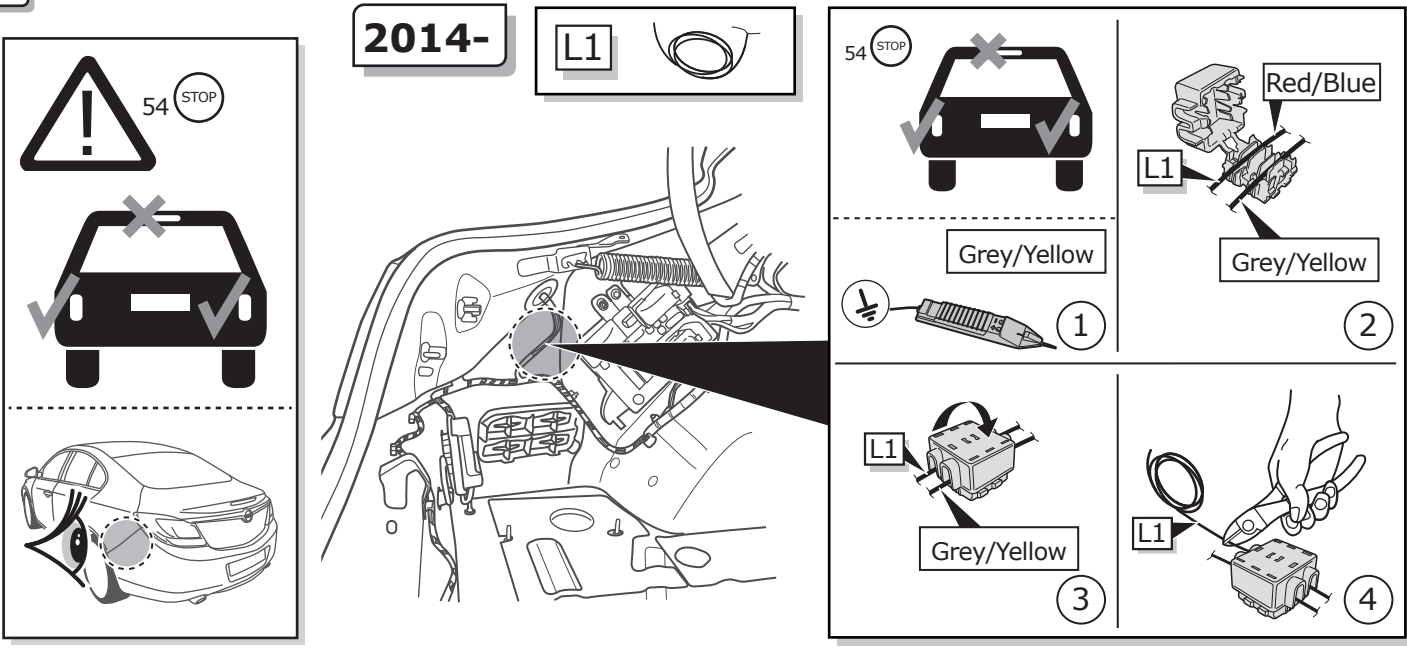

9

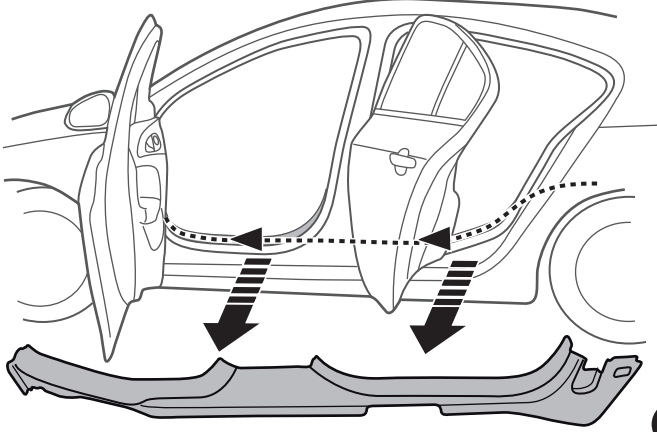

1

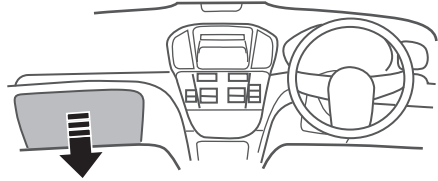

2

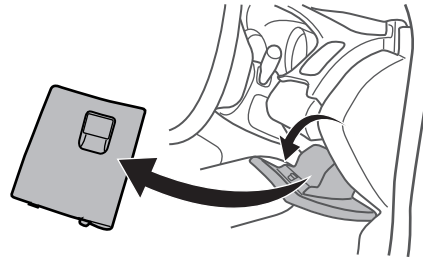

3

10

Option 1

1

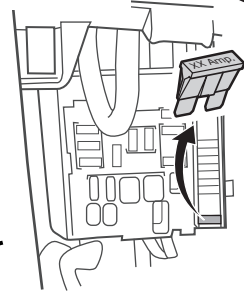

2

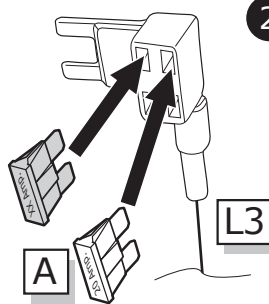

3

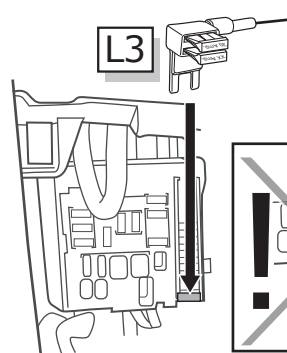

Option 2

1

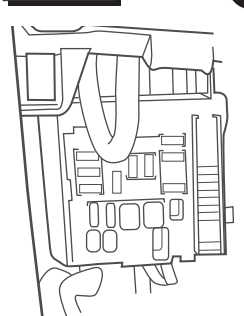

2

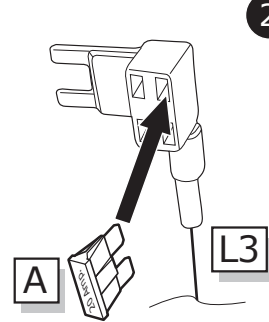

3

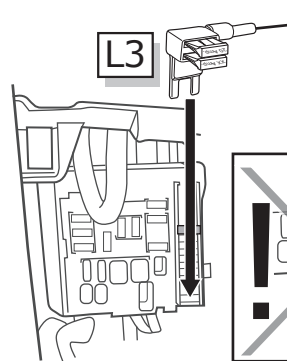

11

Option 1

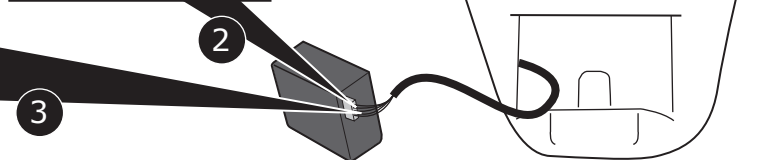
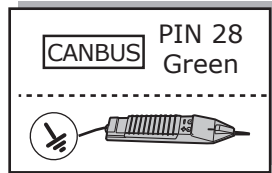
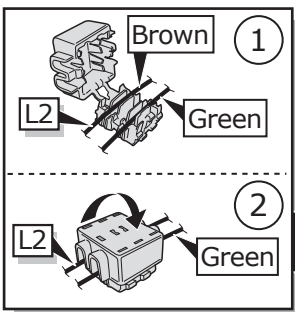
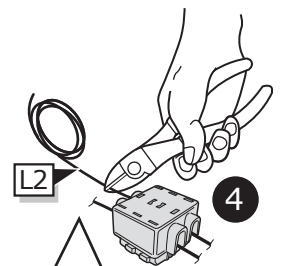
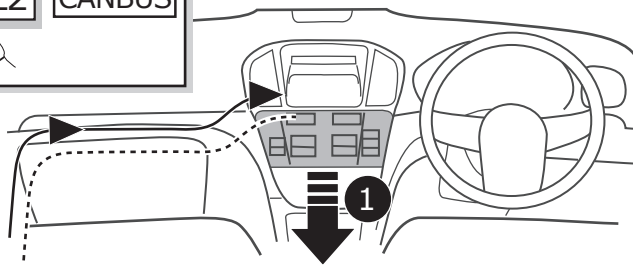
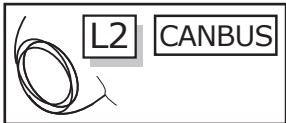
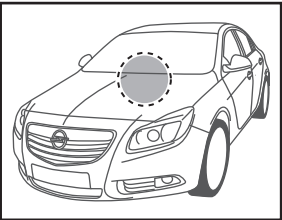

12

Option 2

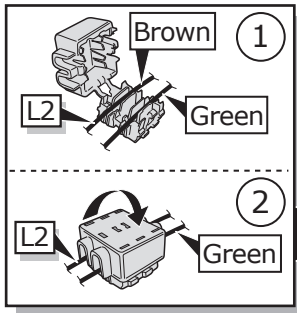
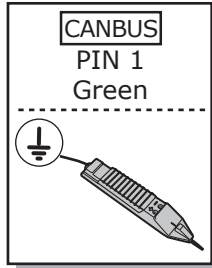
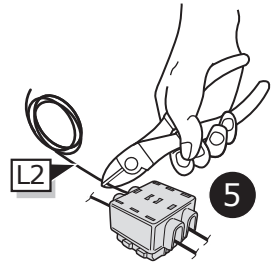
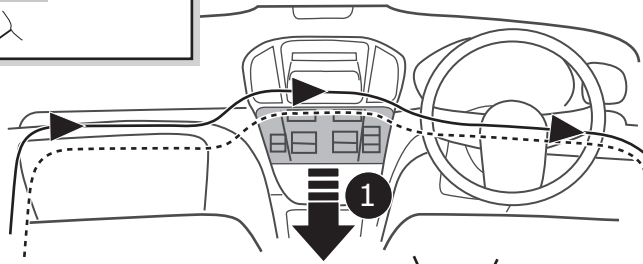
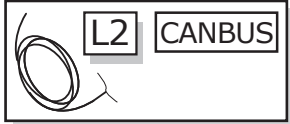
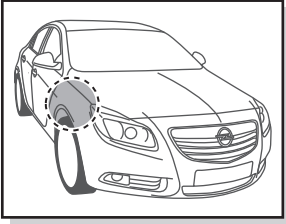

3

2

4

13



Pag. 35

INFO

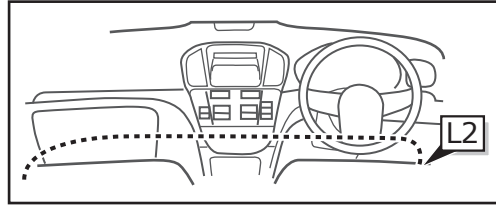
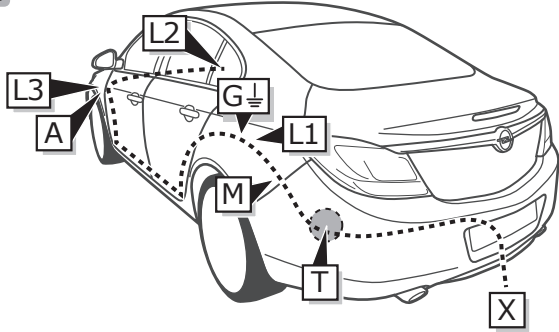

Insignia HB

Pag. 9

-
Pag. 12

1

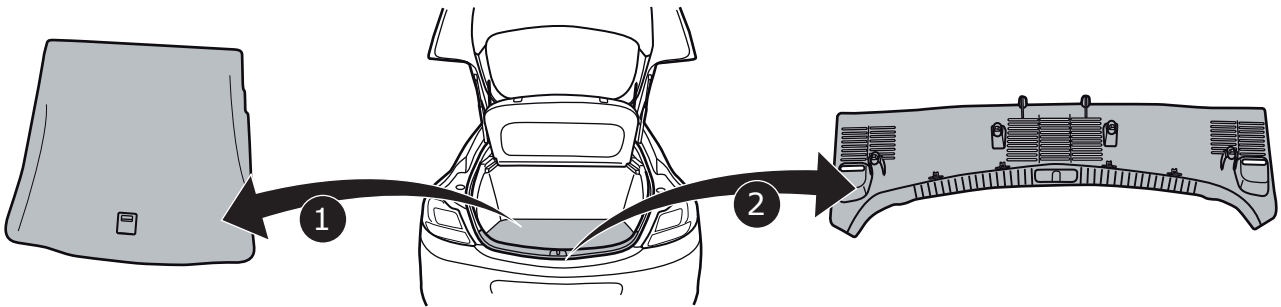

2

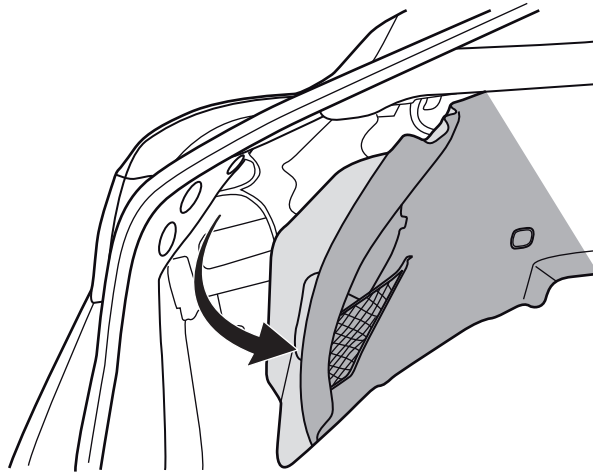

3

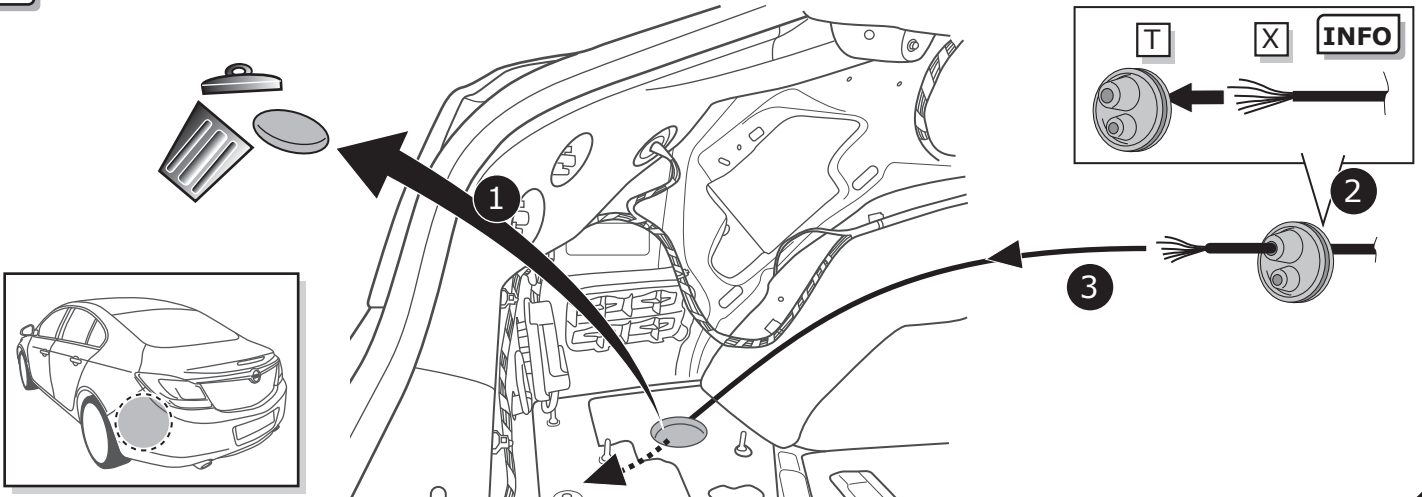

4



5

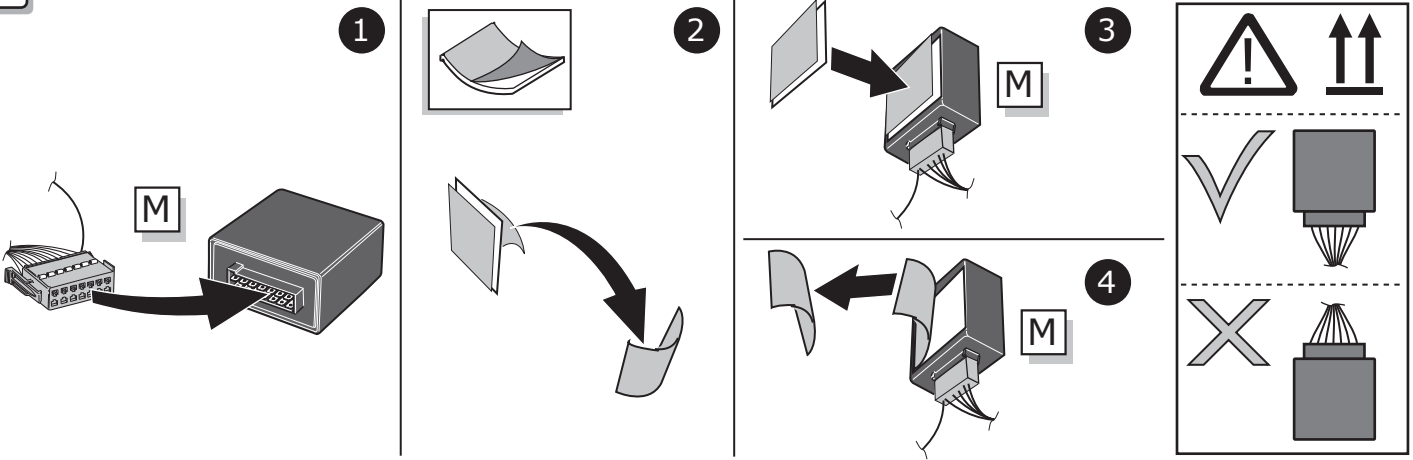

6

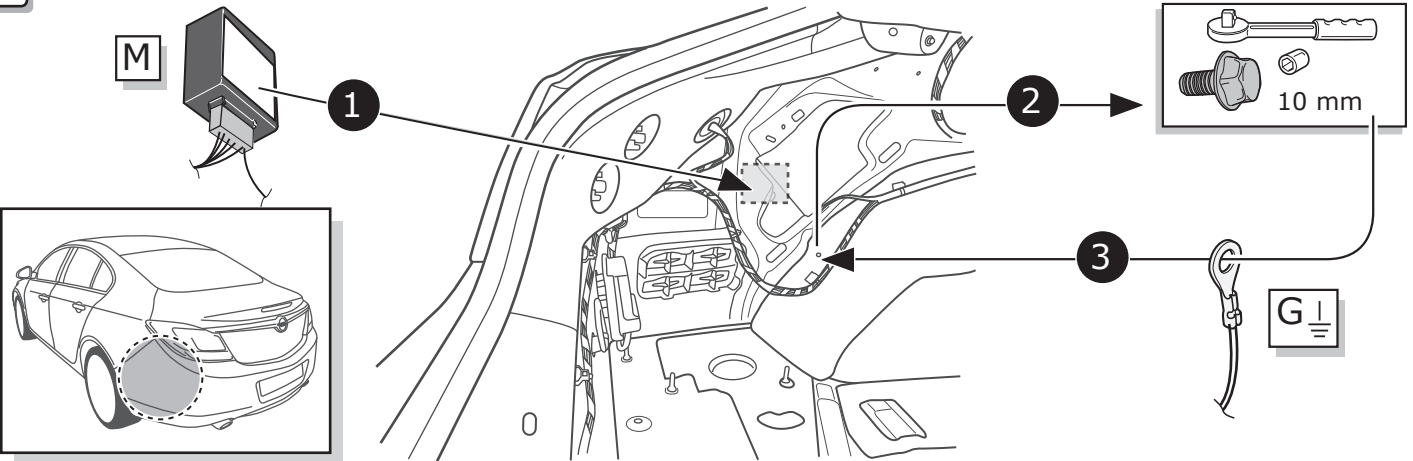

7

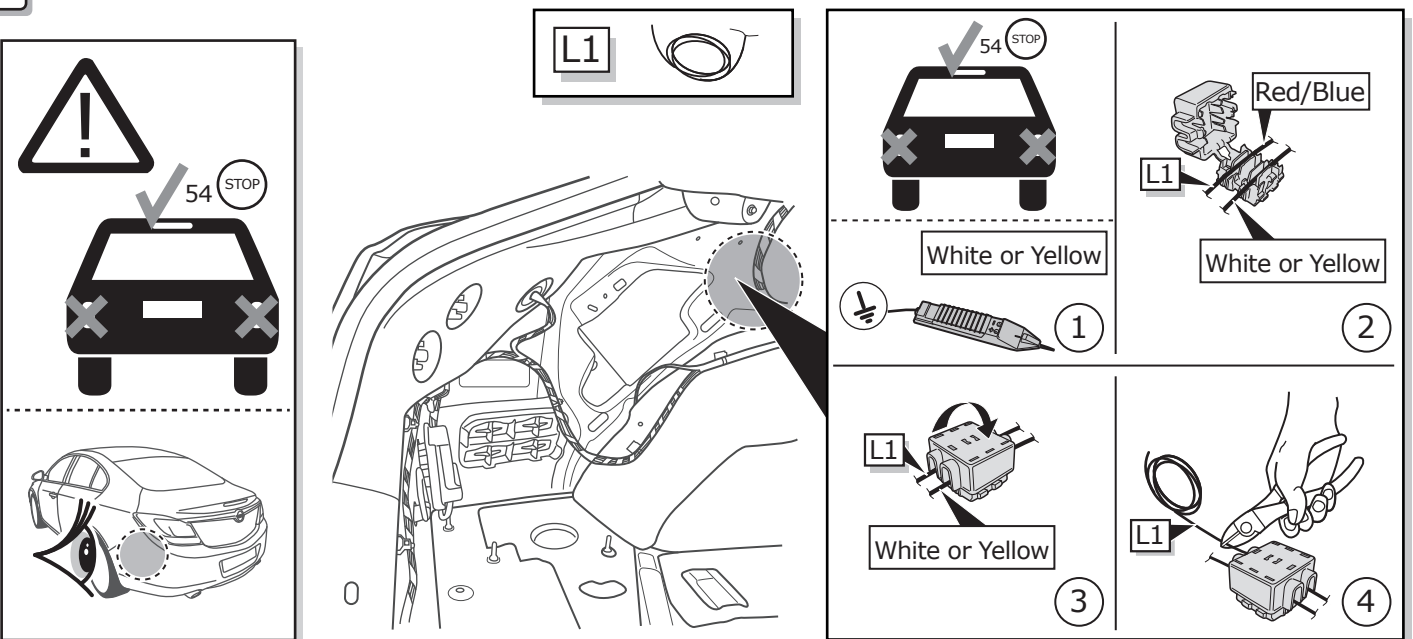

8

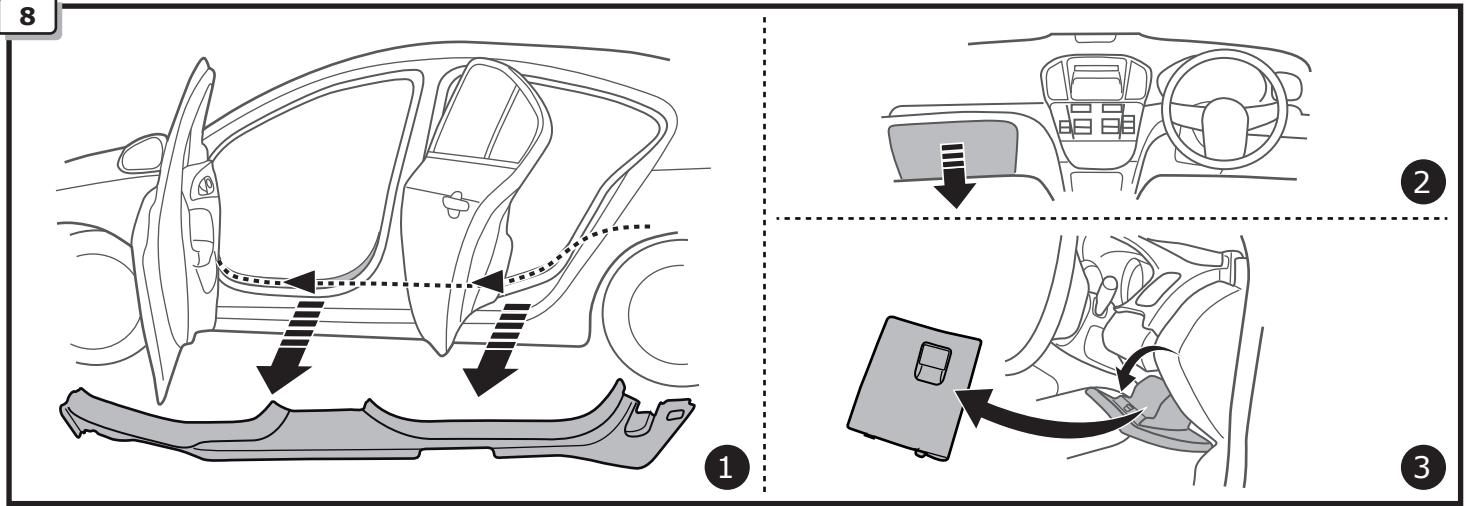

9

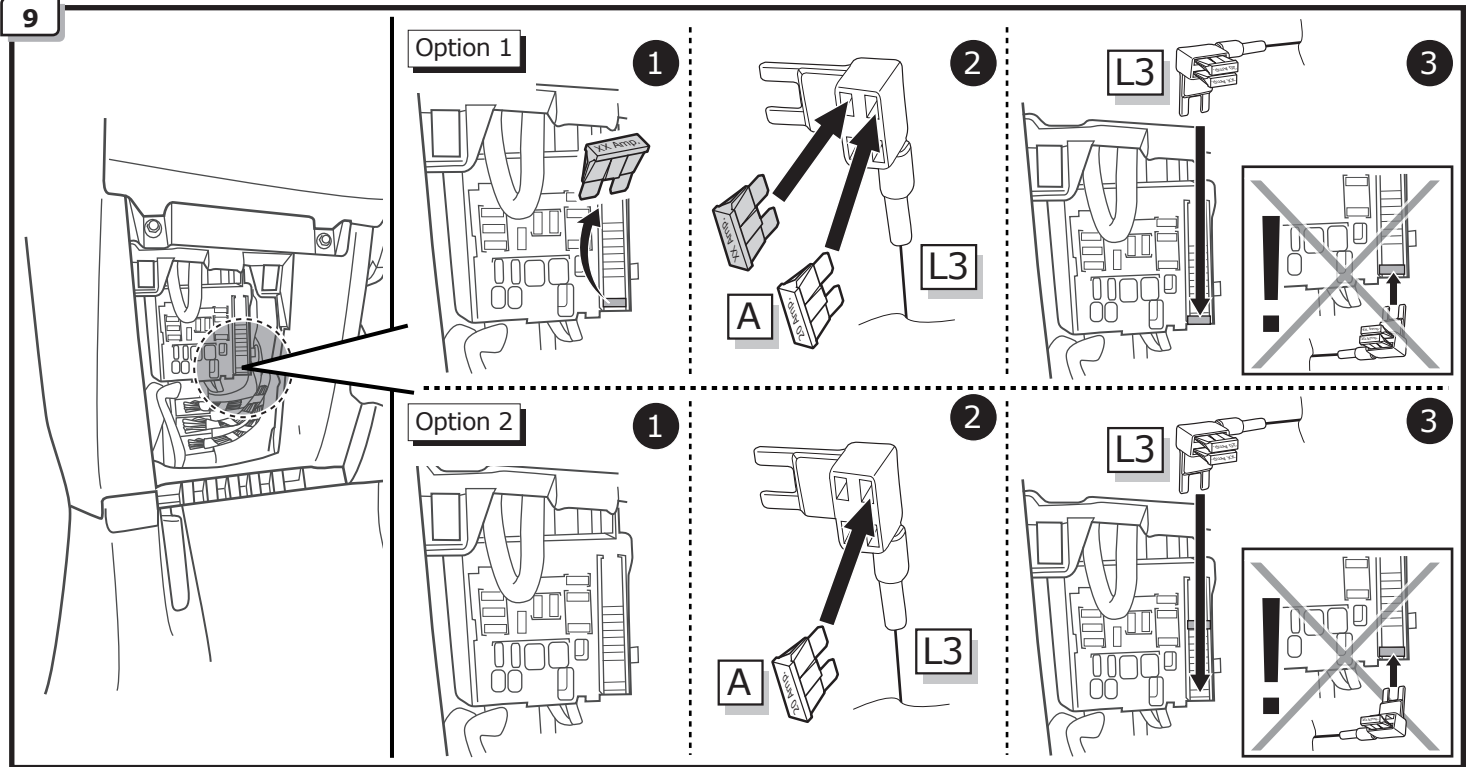

10

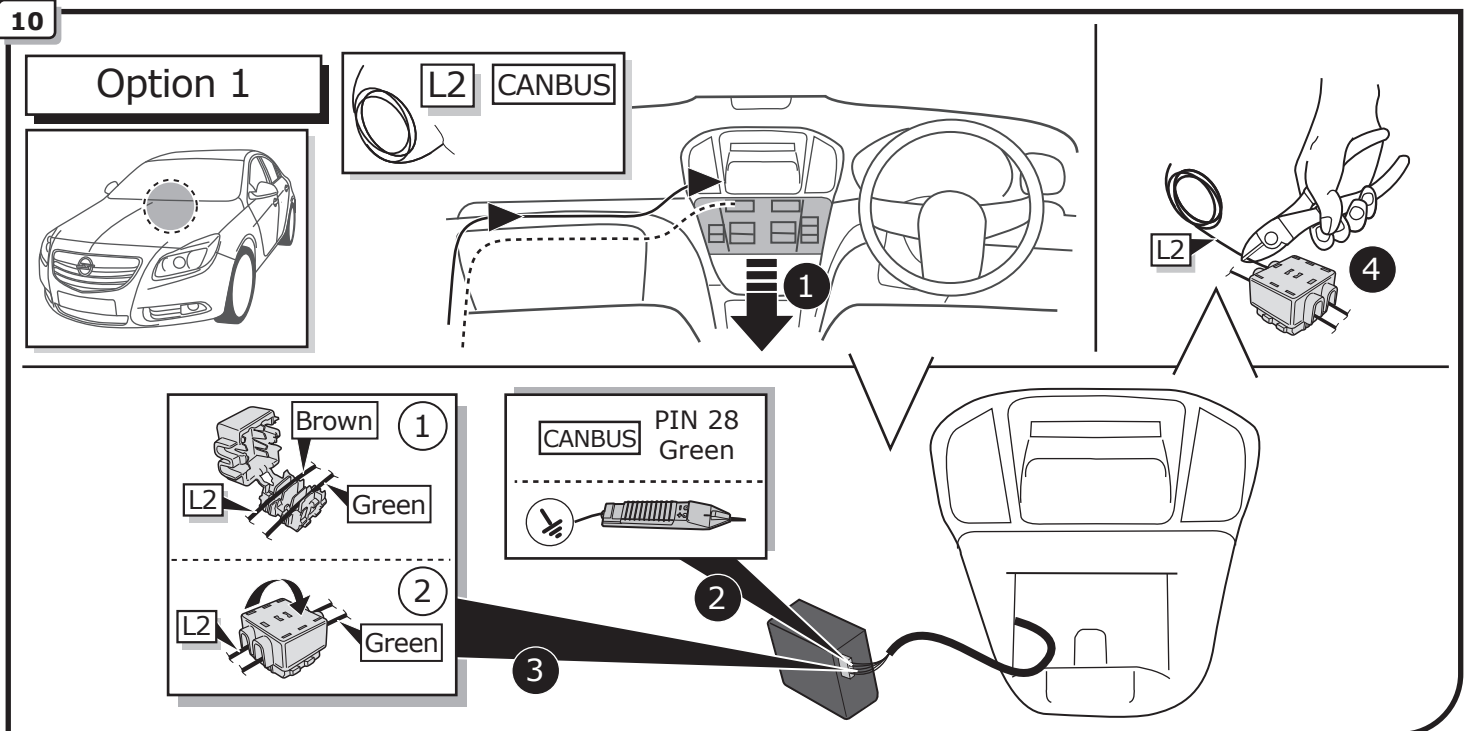

11

Option 2

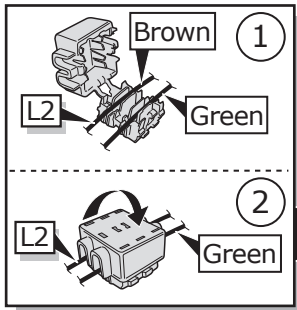
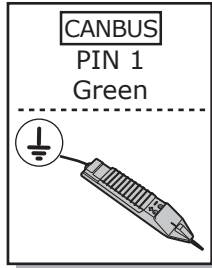
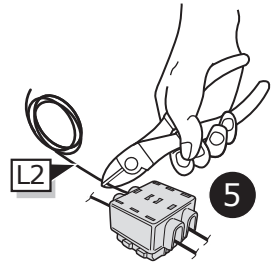
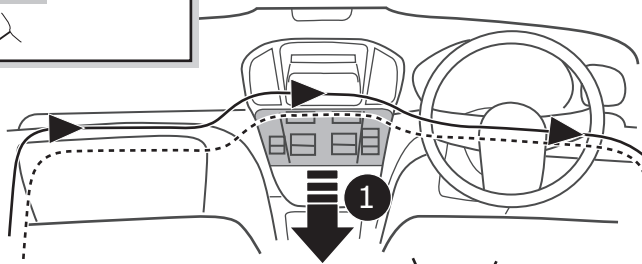
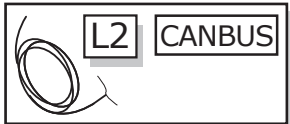
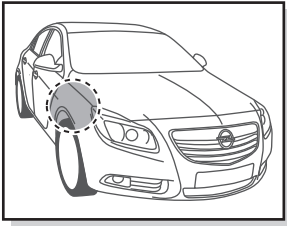

3

2

4

12



INFO

Insignia ST

Pag. 13

-
Pag. 17

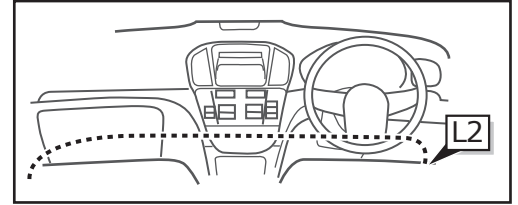
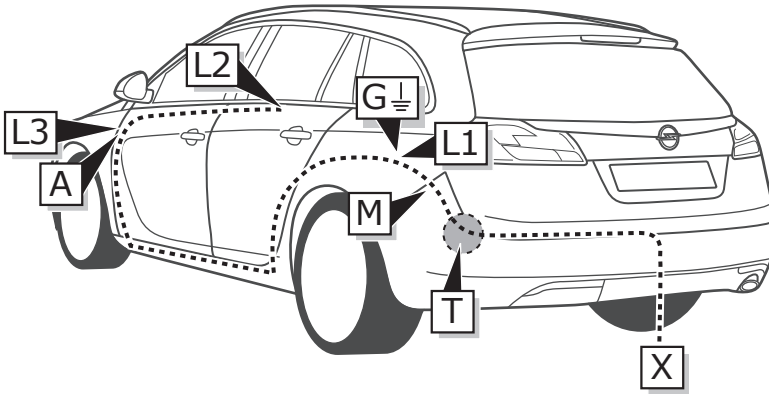

1

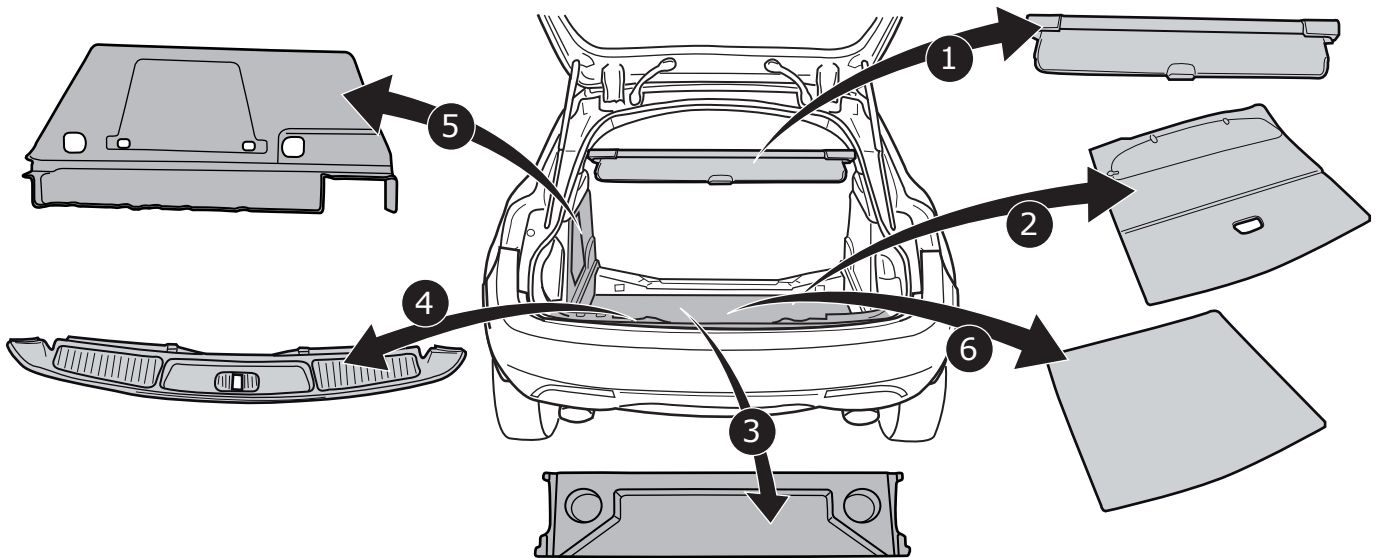

2

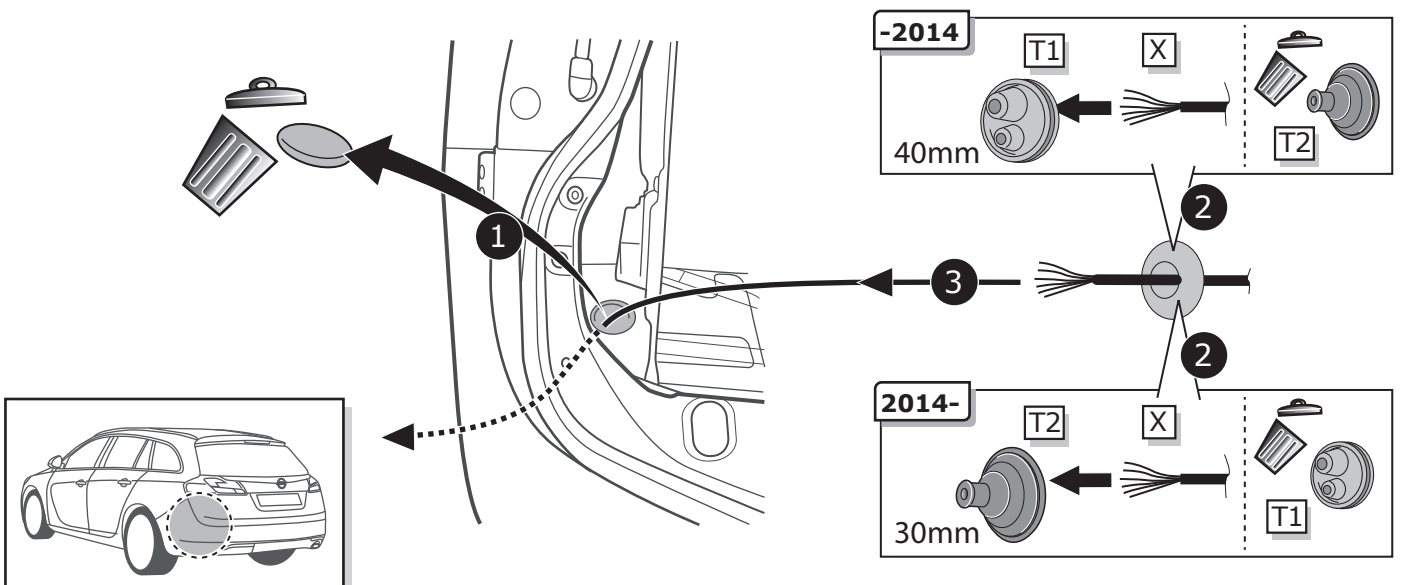

3



4

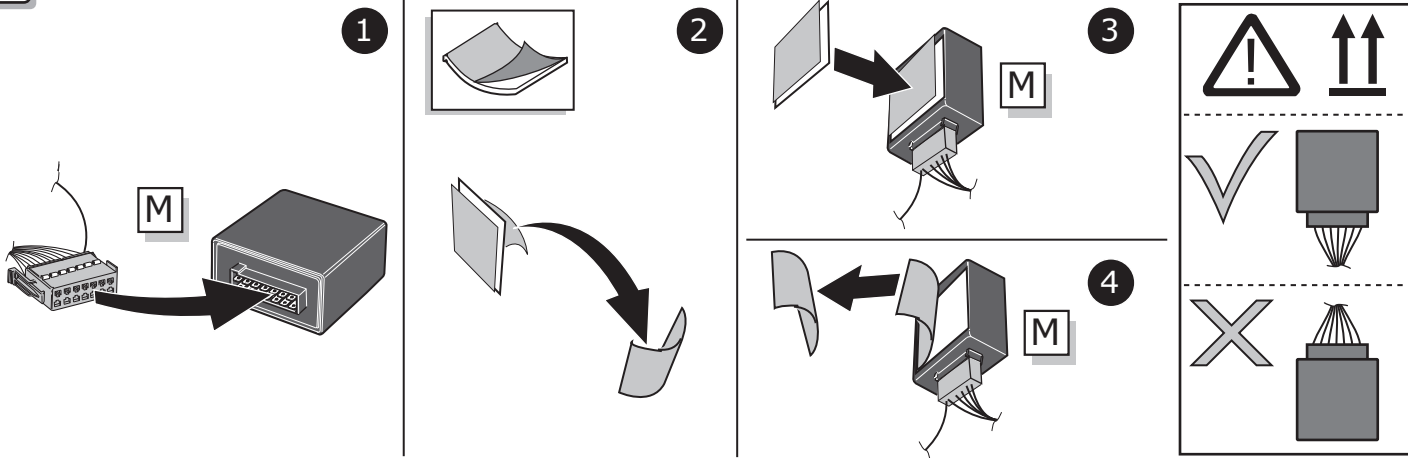

5

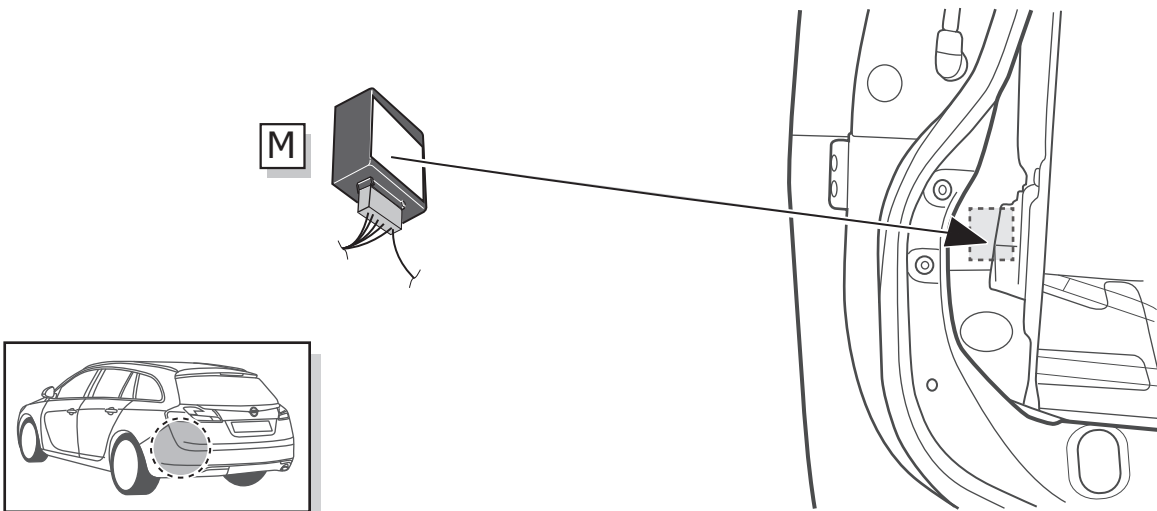

6

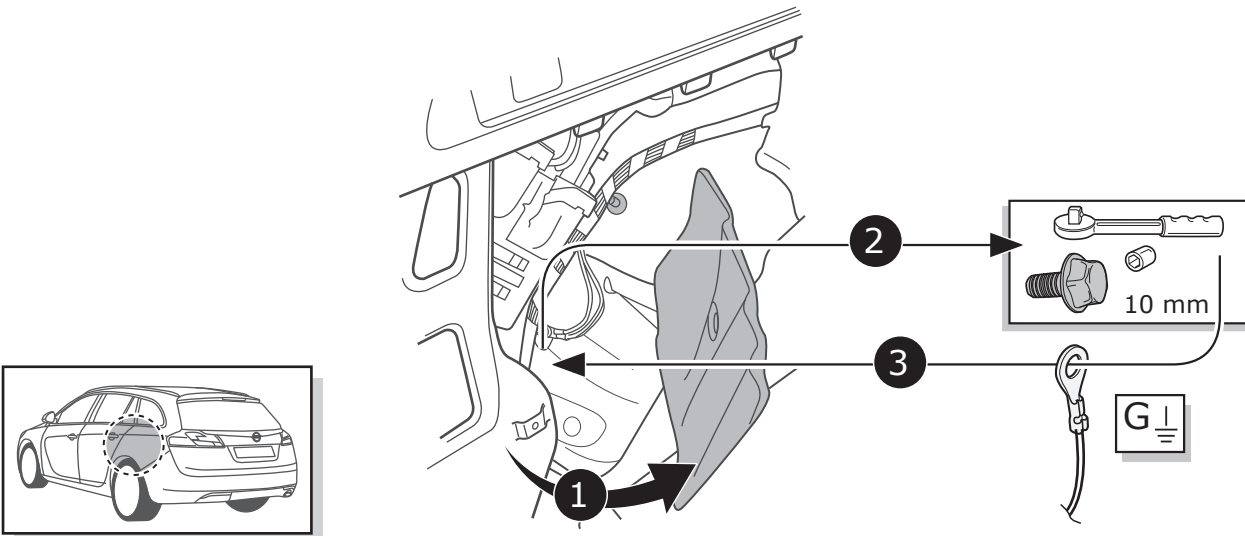

7

-2014

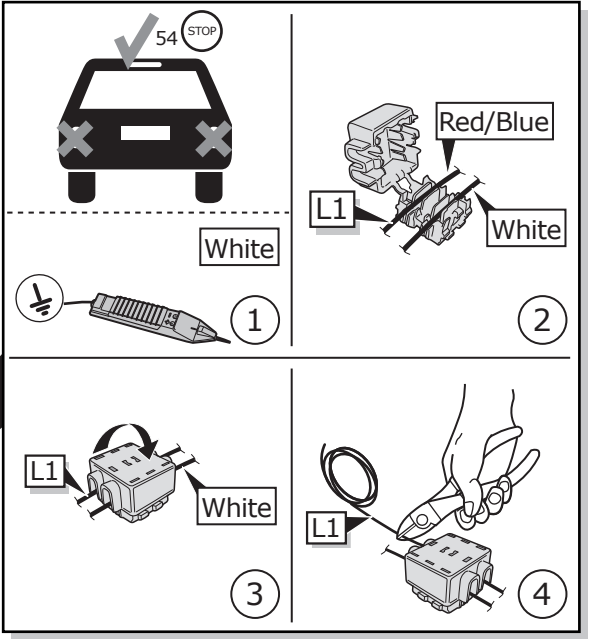
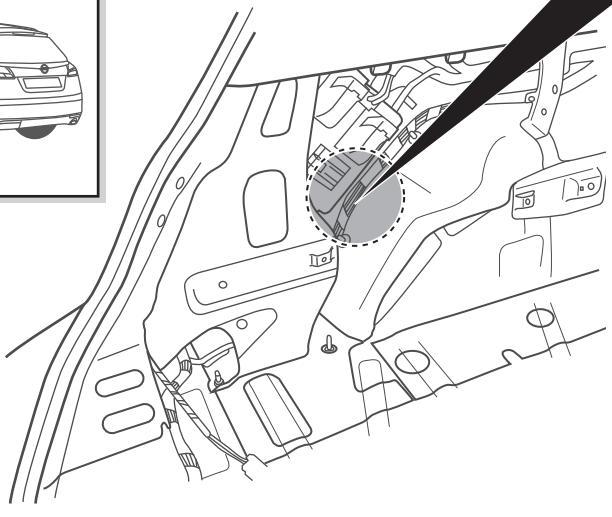
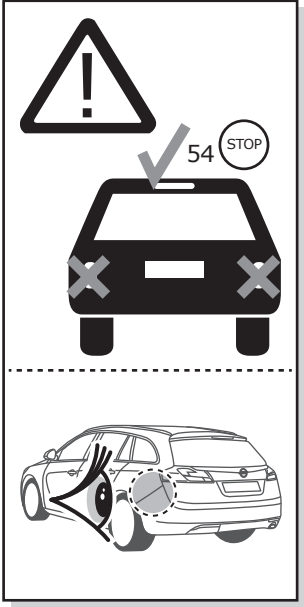

8

2014-

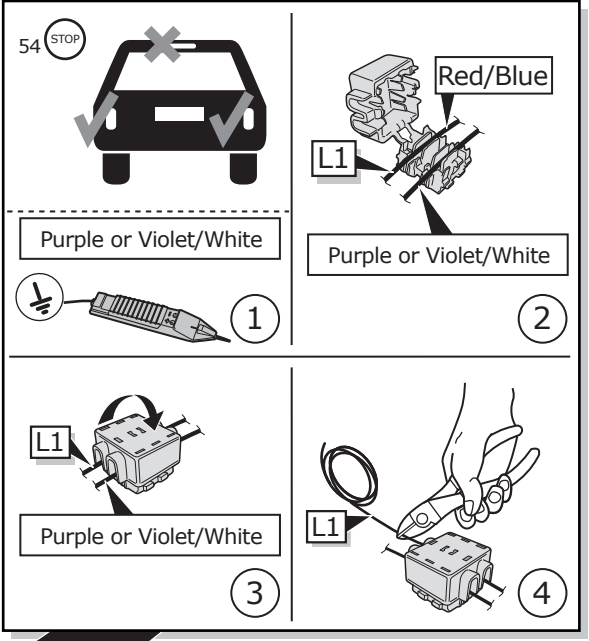
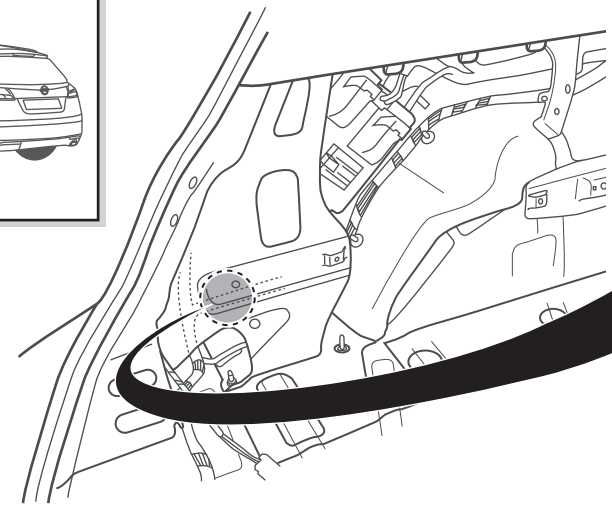
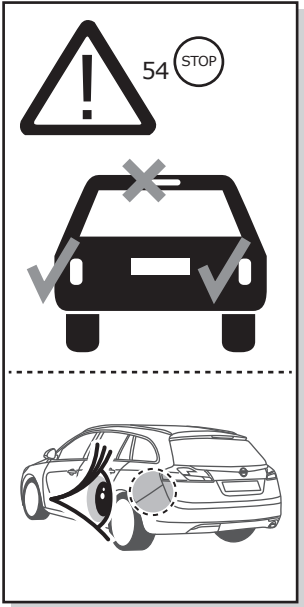

9

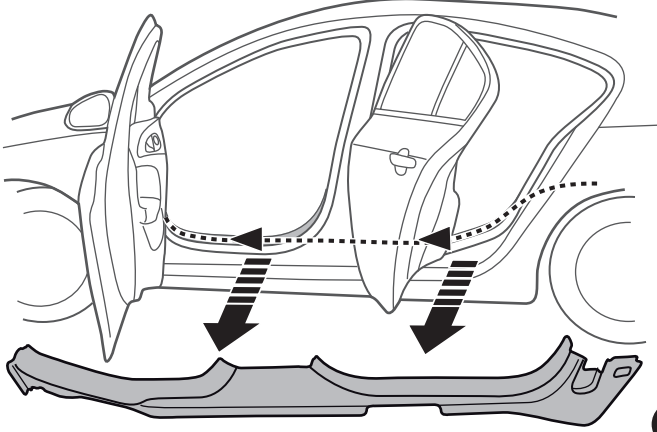

1

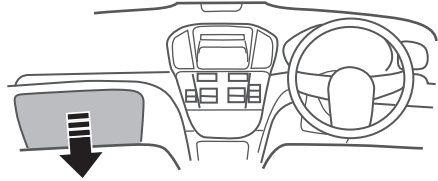

2

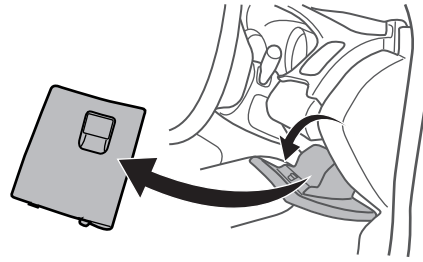

3

10

Option 1

1

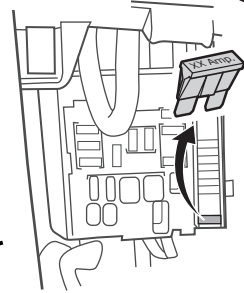

2

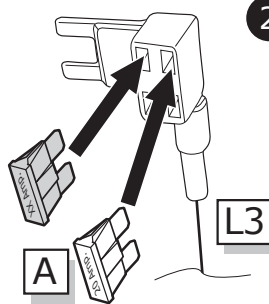

3

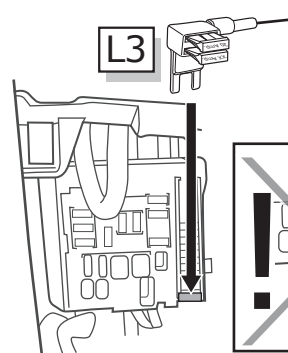

Option 2

1

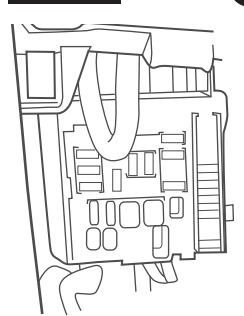

2

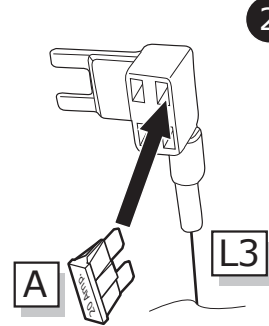

3

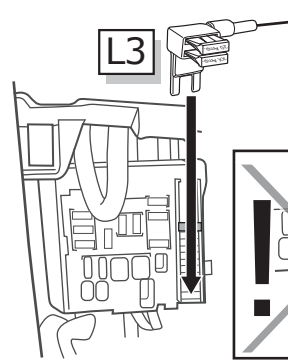

11

Option 1

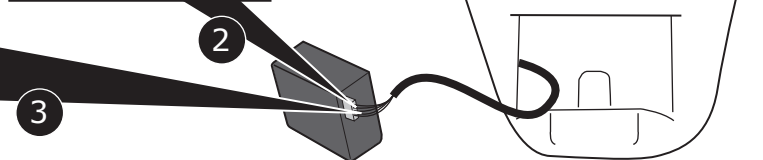
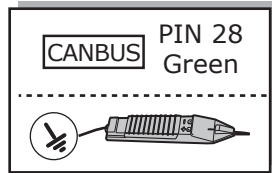
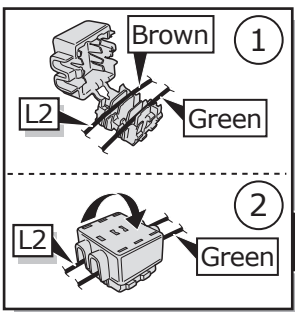
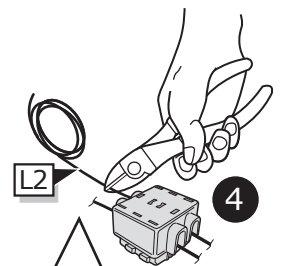
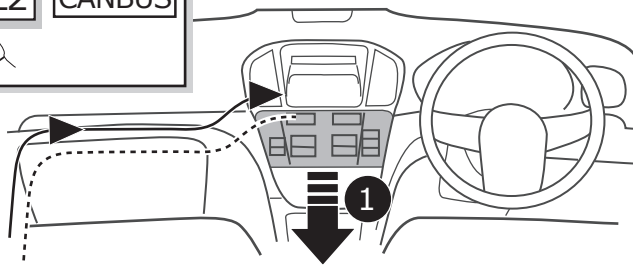
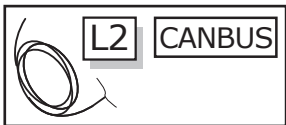
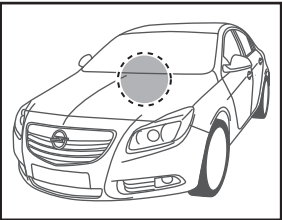

12

Option 2

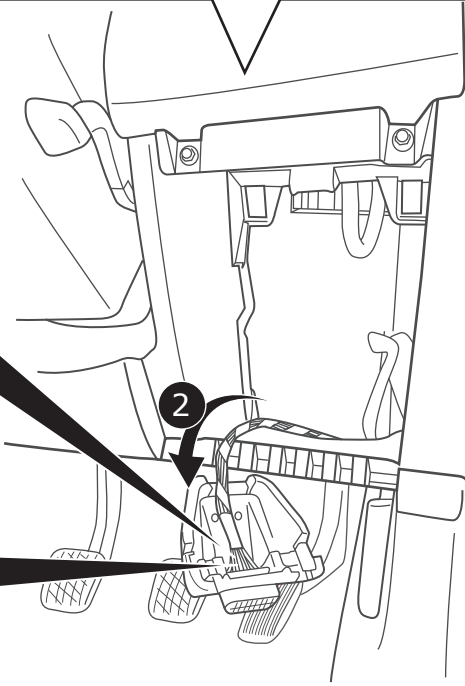
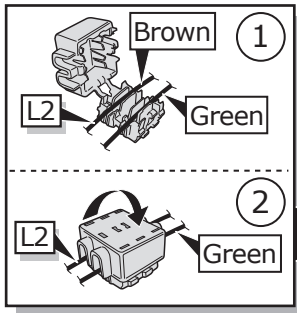
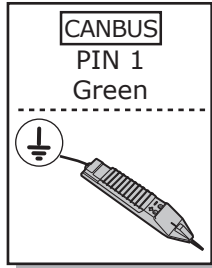
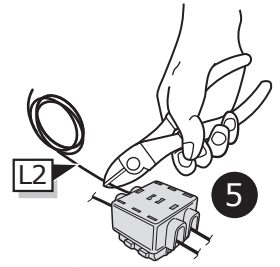
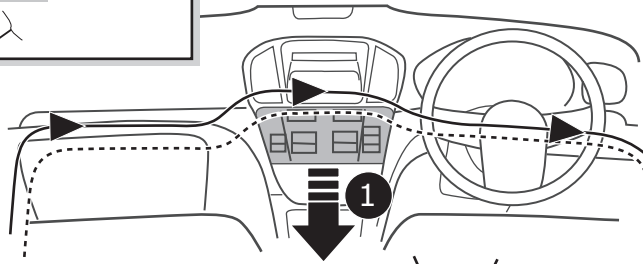
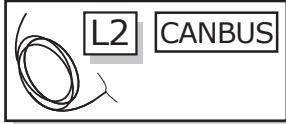
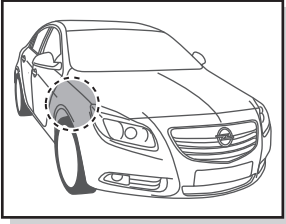

13



INFO

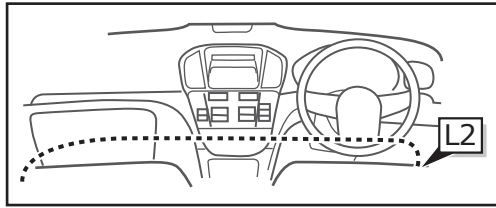
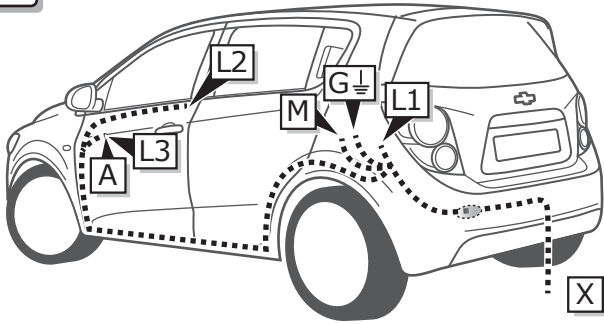

Aveo HB

Pag. 18

Pag. 20

1

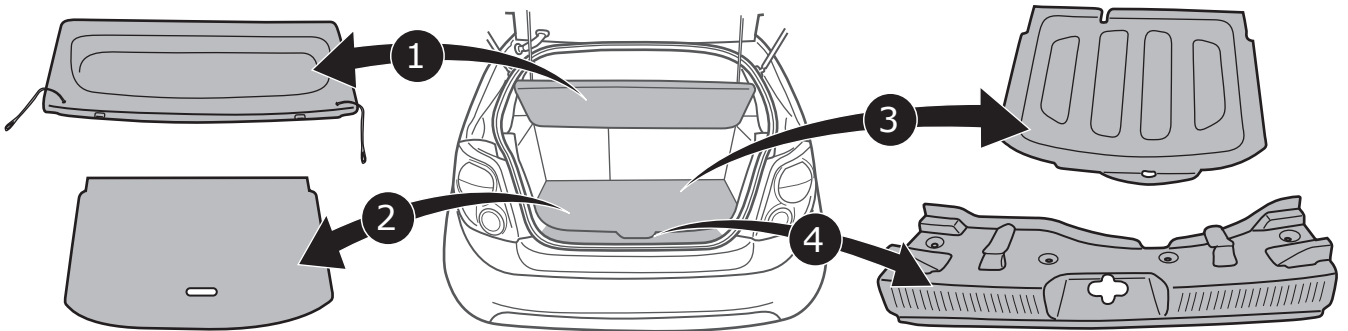

2

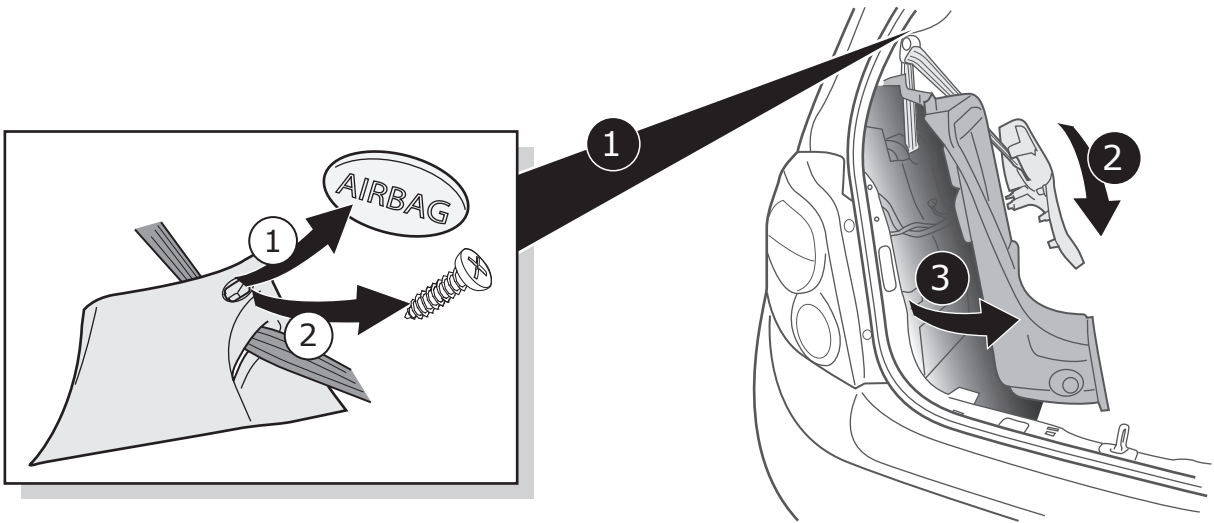

3

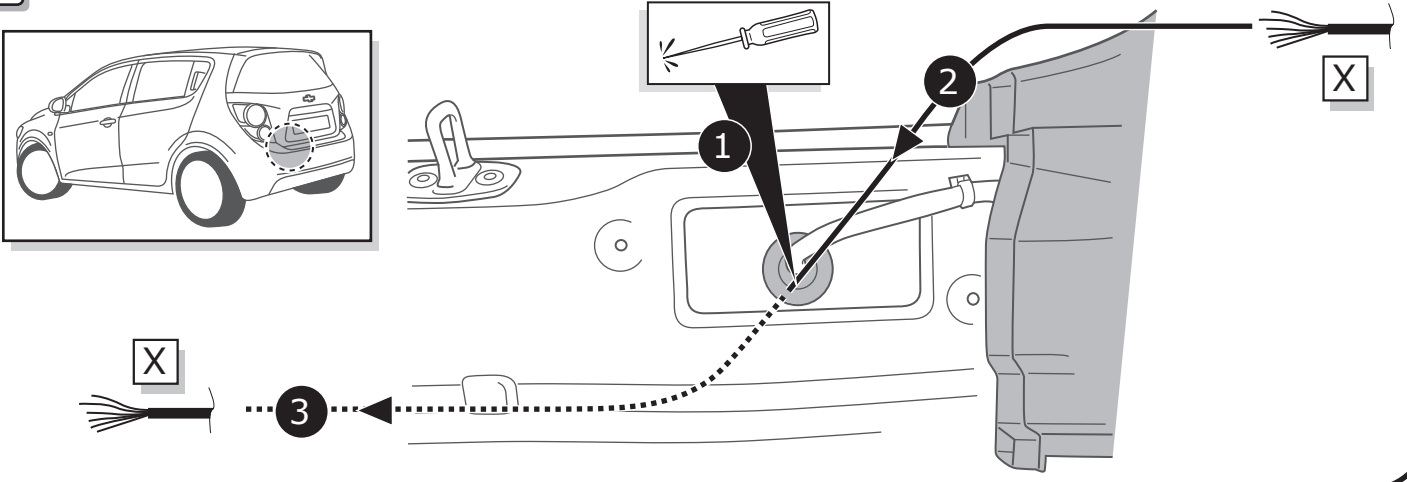

4



Pag. 34

5

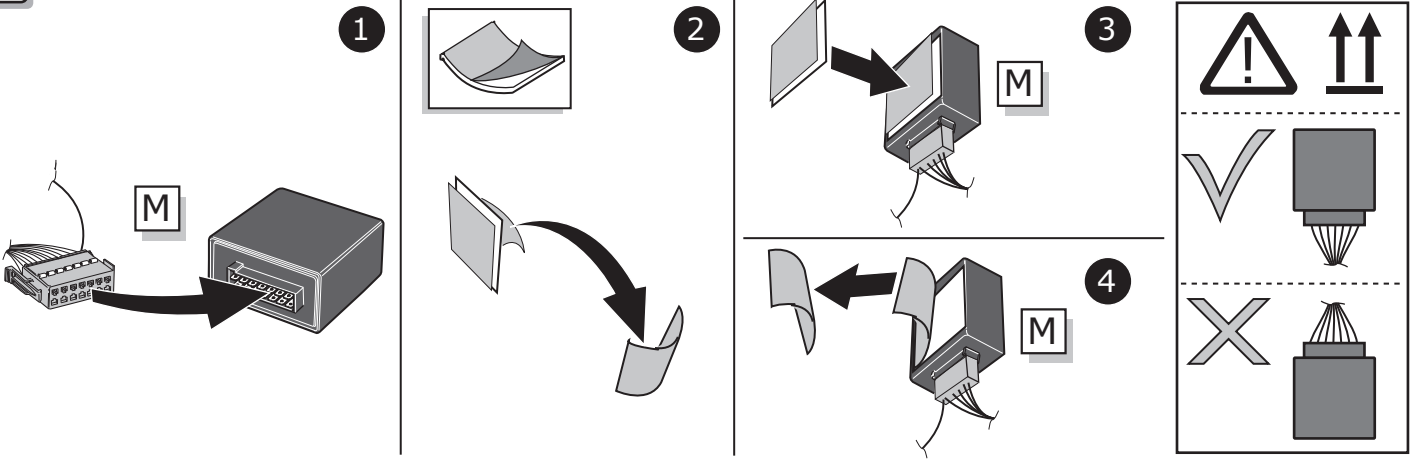

6

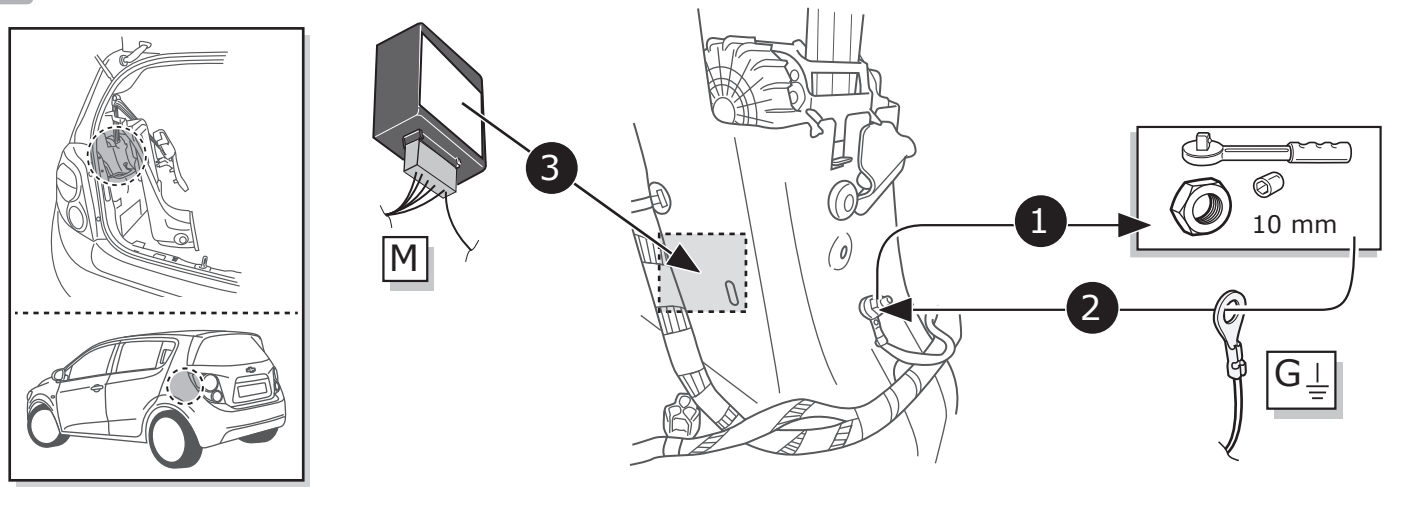

7

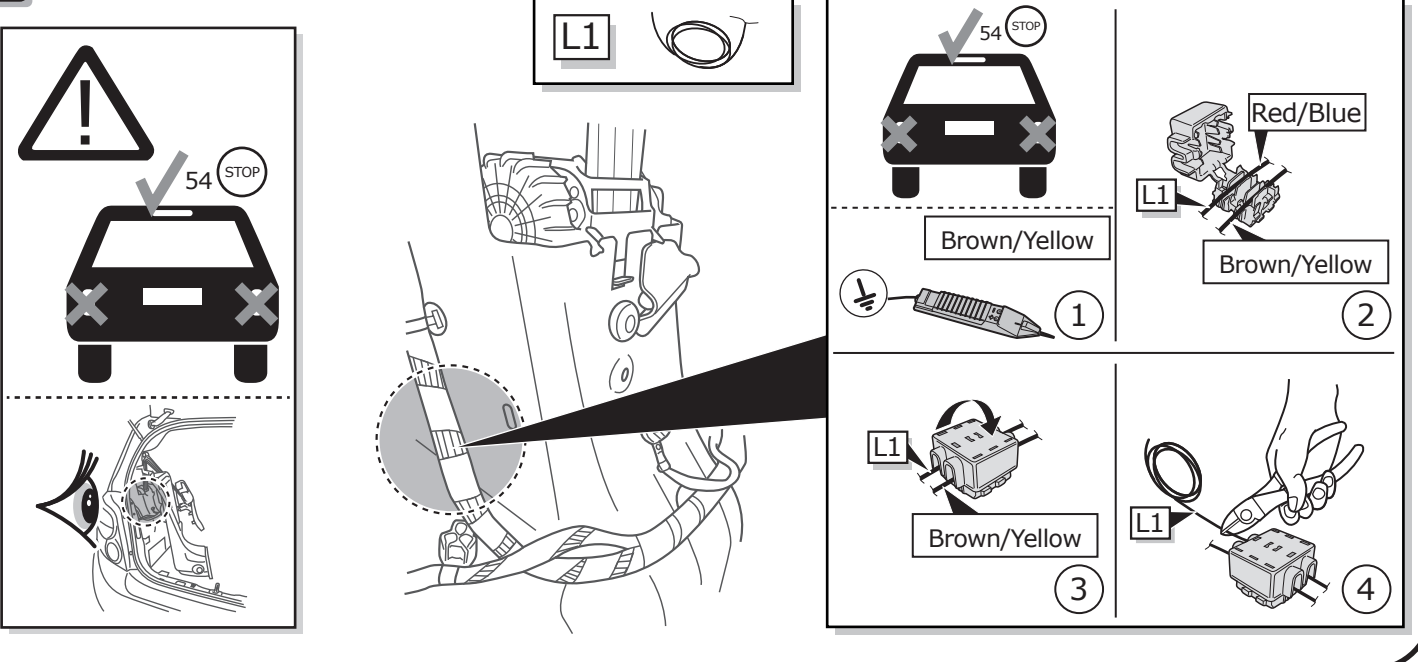

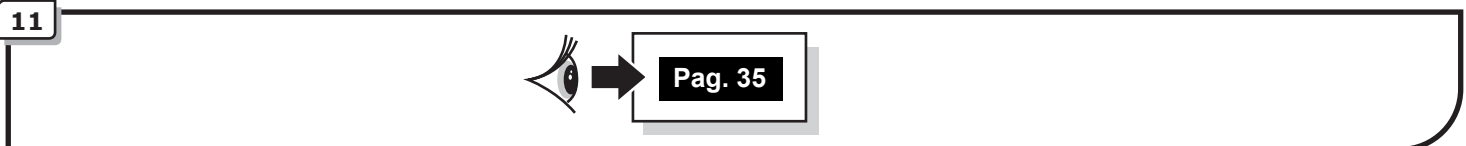
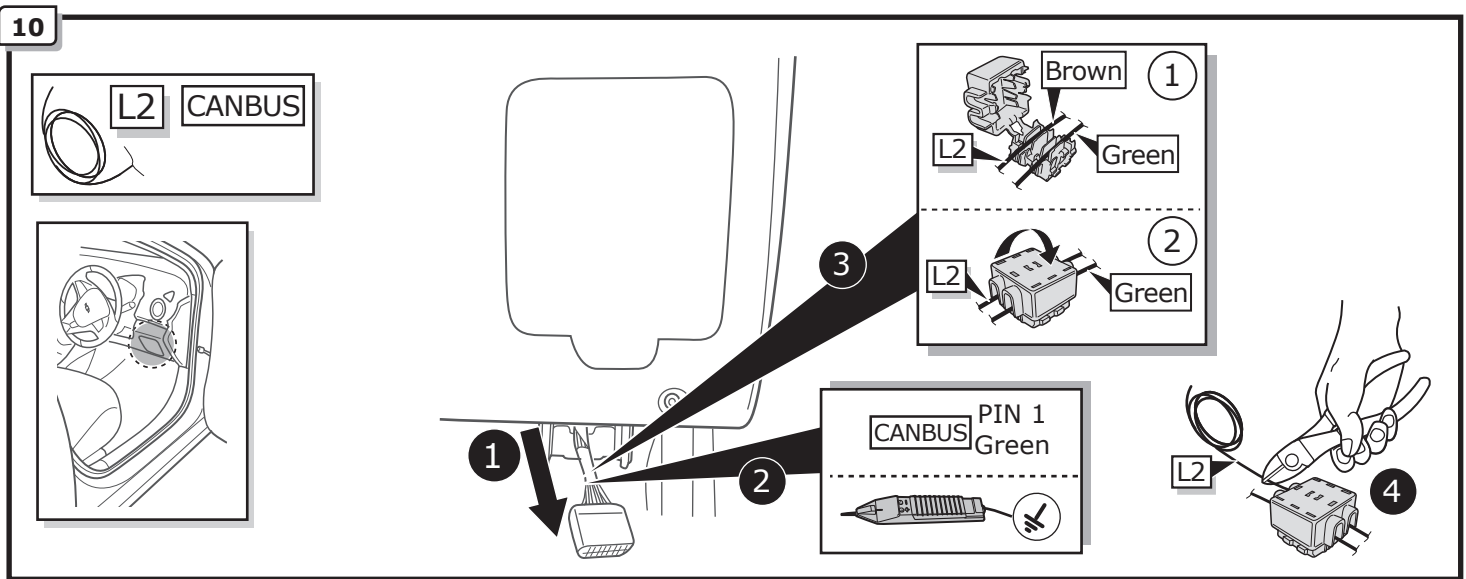
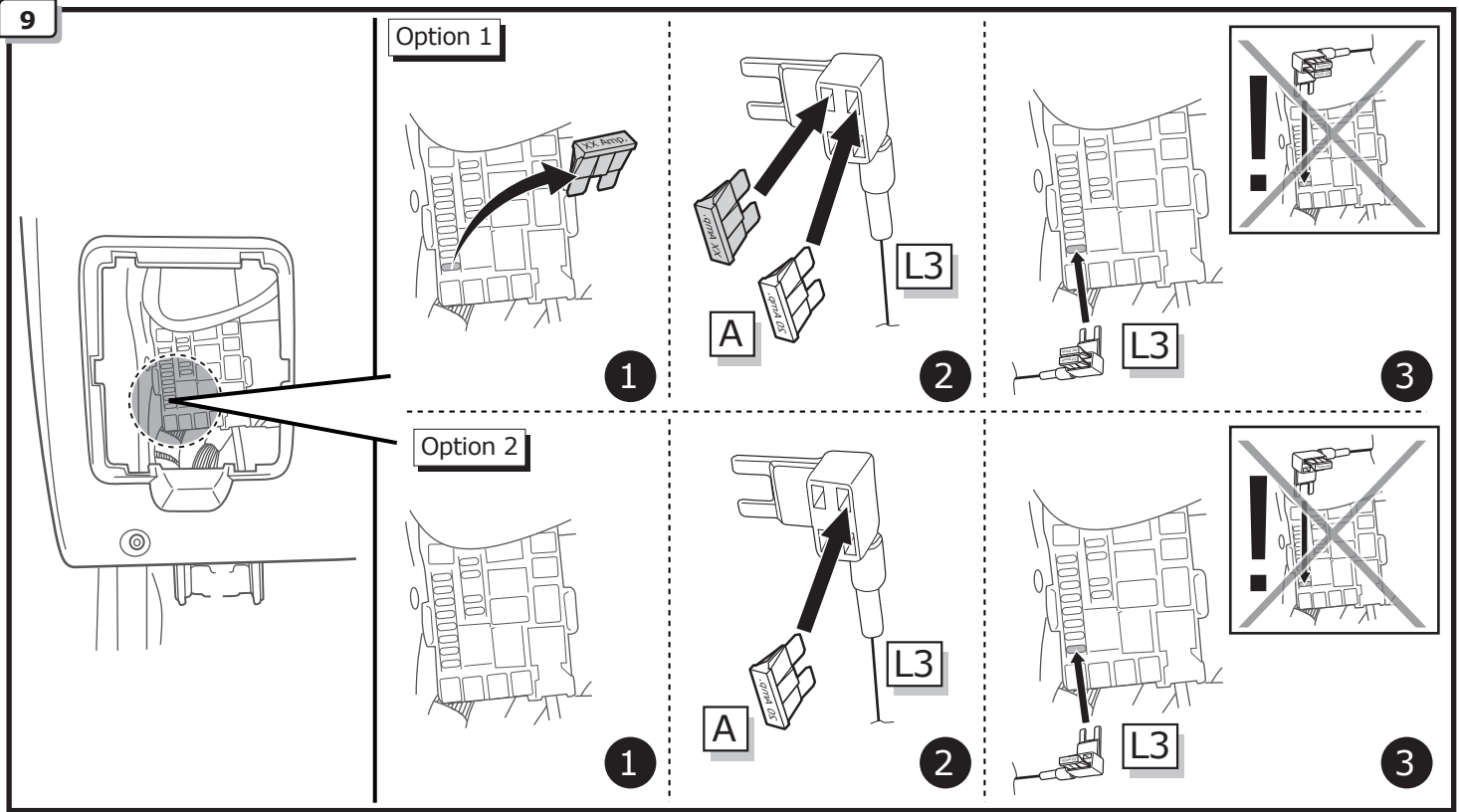
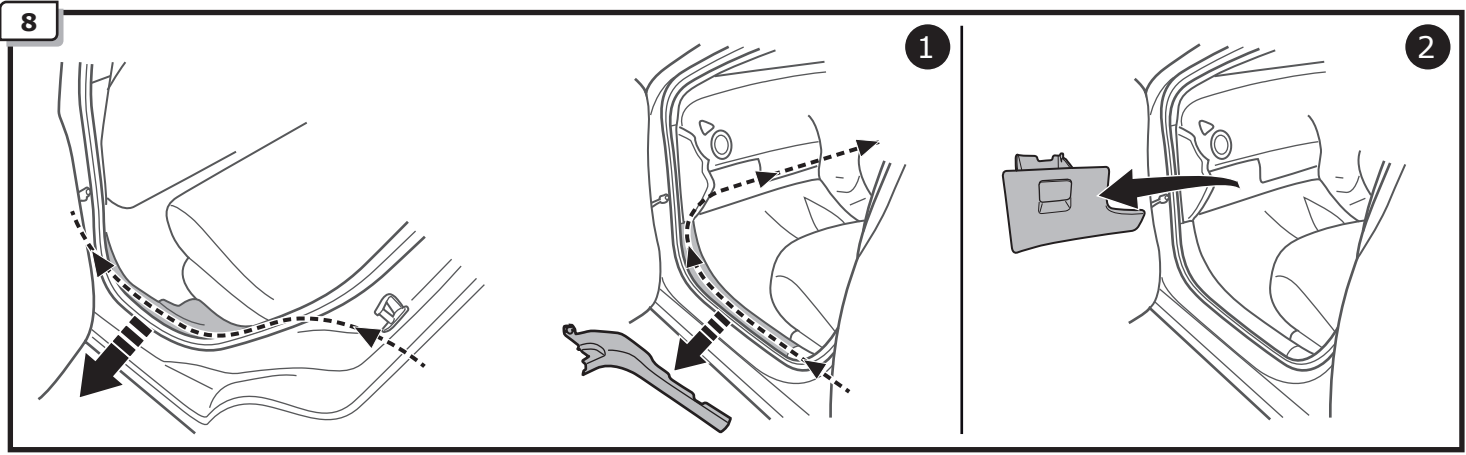

INFO

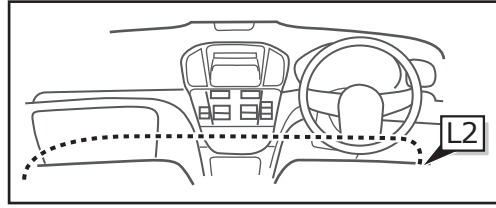
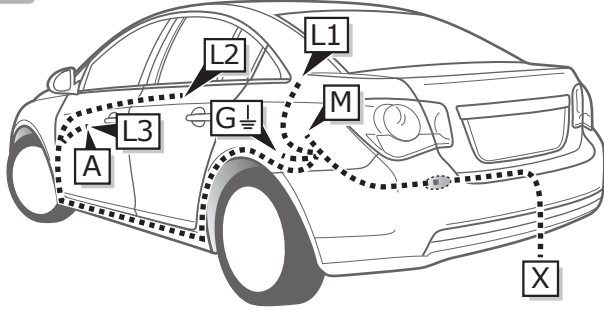

Aveo SD

Pag. 21

Pag. 23

1

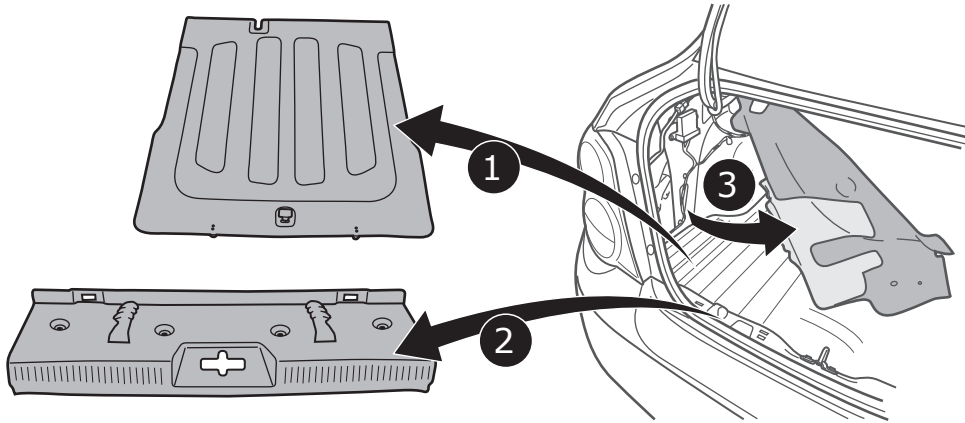

2

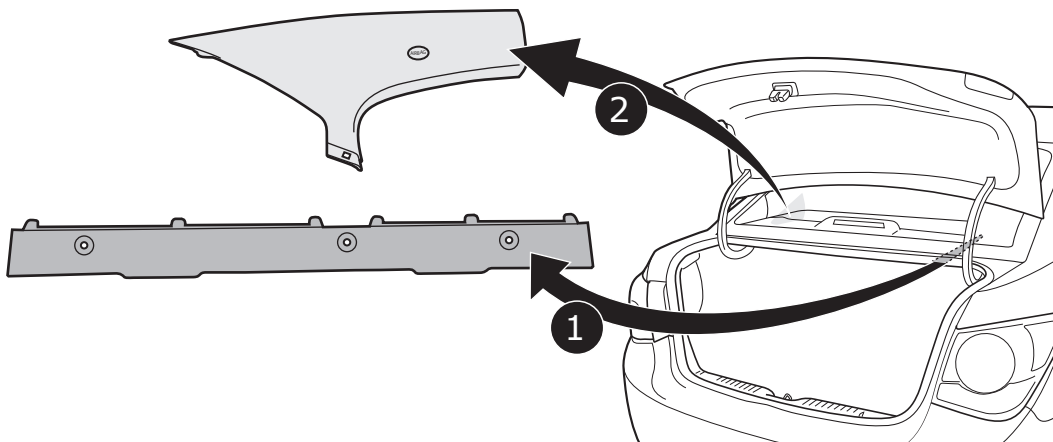

3

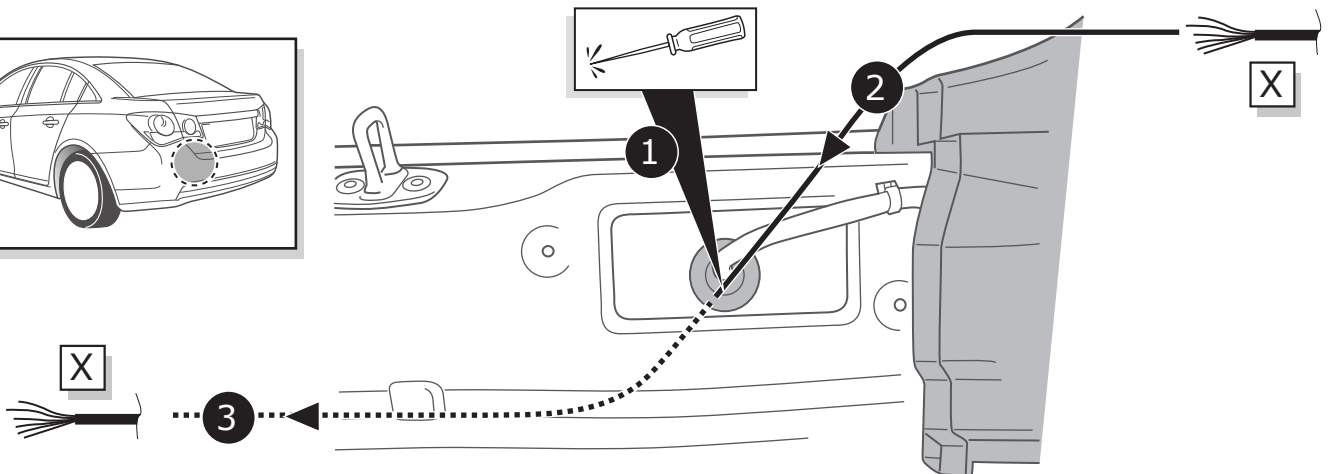
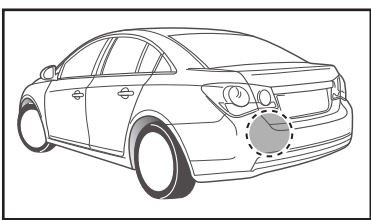

4



Pag. 34

5

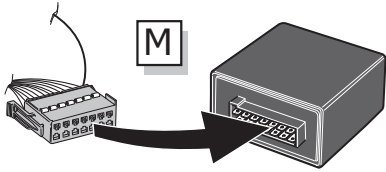

1



2

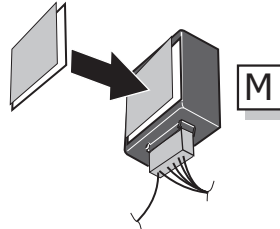
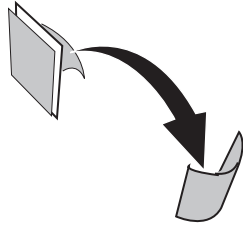

3

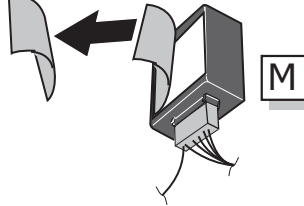

4

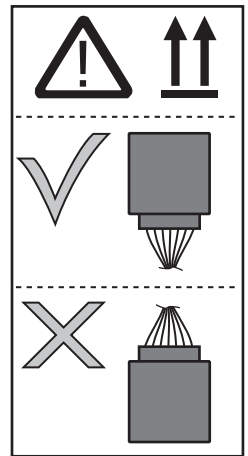

6

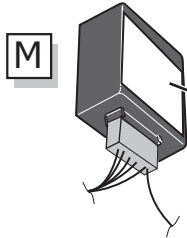
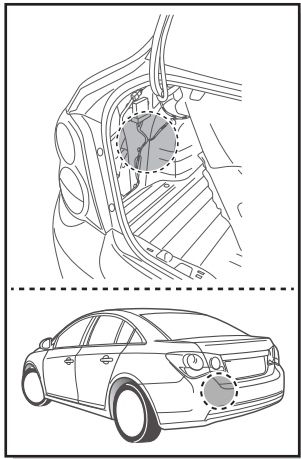

2

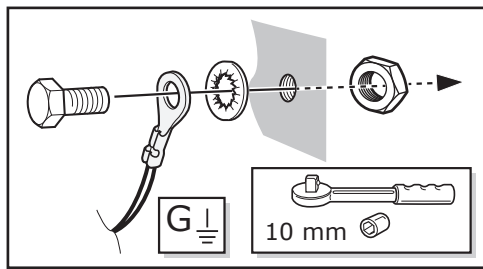

G

10 mm

1

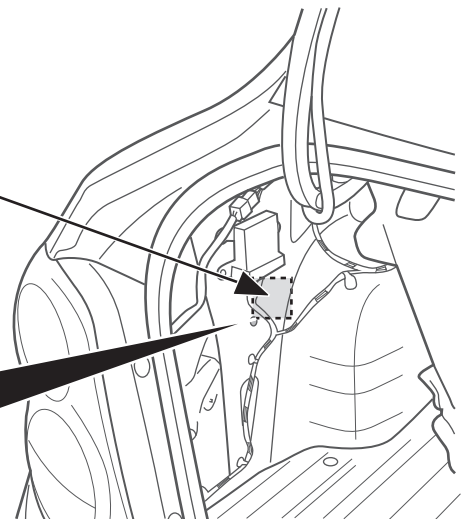

7

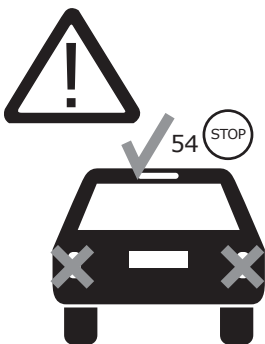

54 STOP



L1

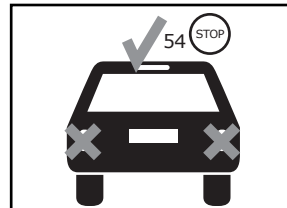
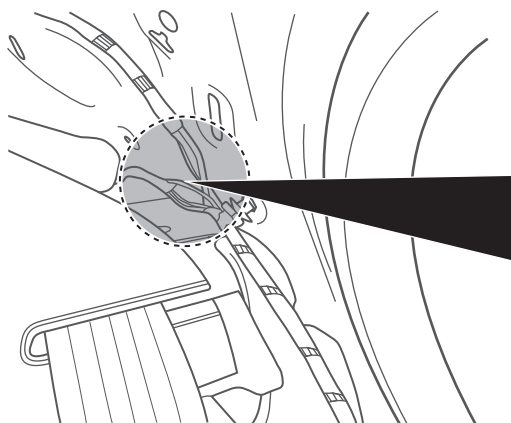

54 STOP

Brown/Yellow

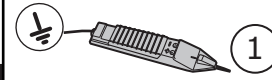

1

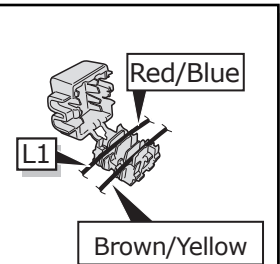

Red/Blue

L1

Brown/Yellow

2

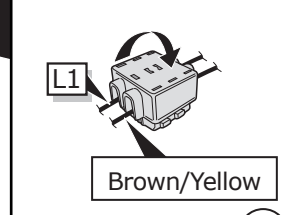

L1

Brown/Yellow

3

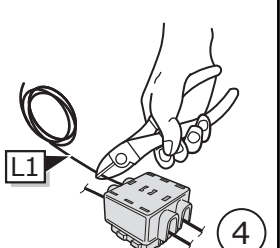

L1

4

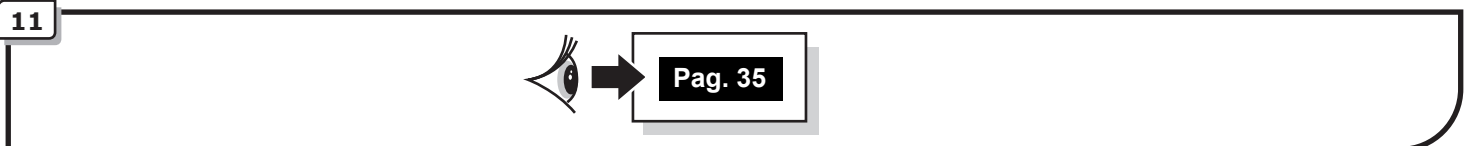
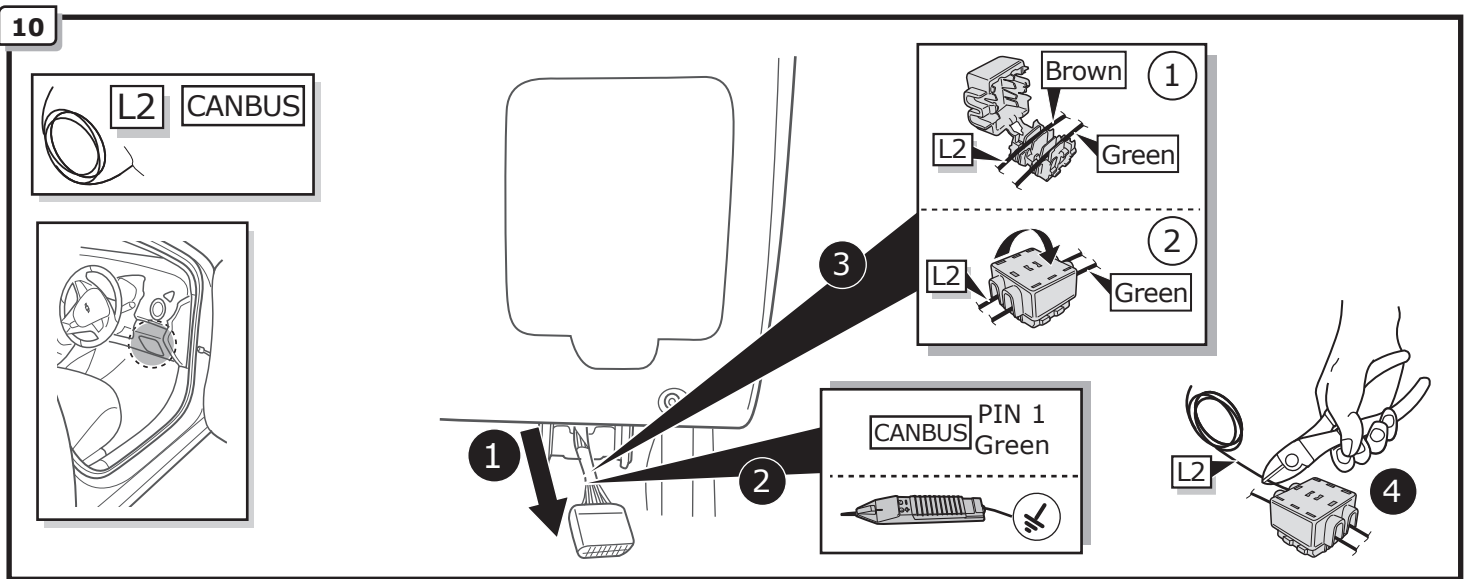
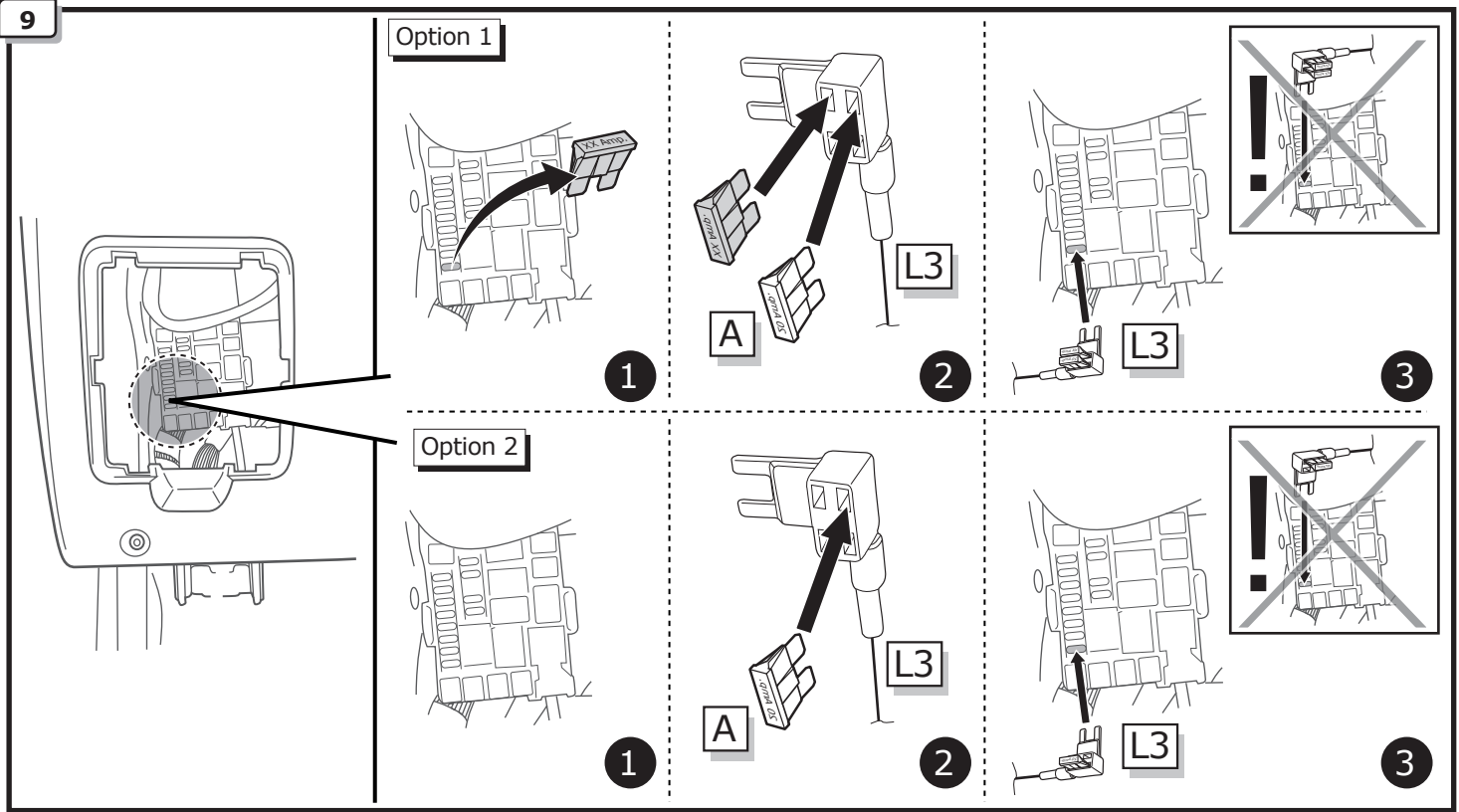
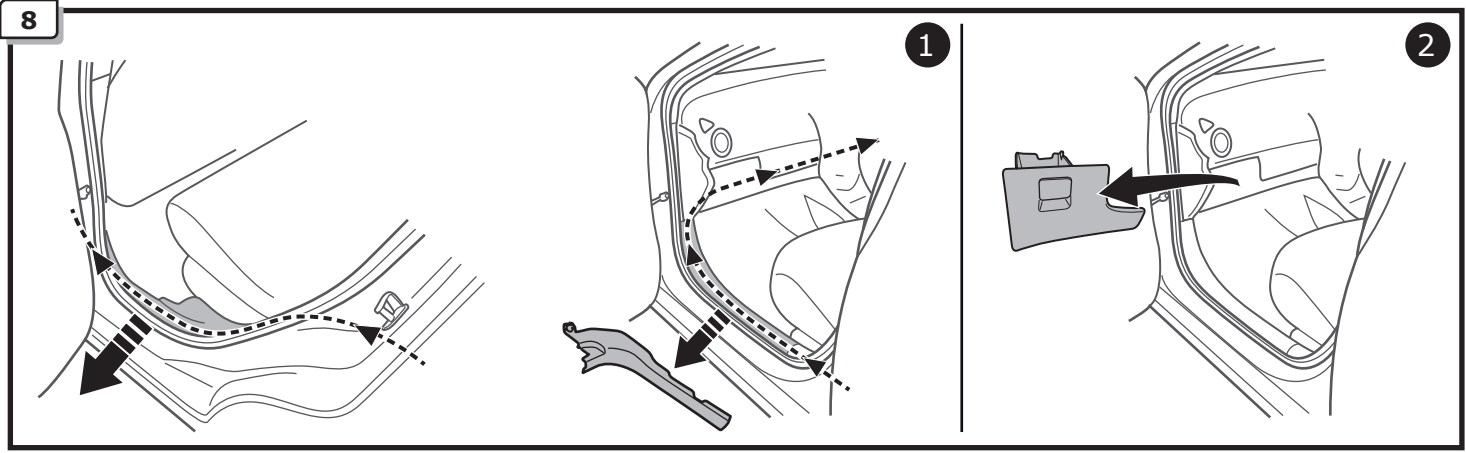

INFO

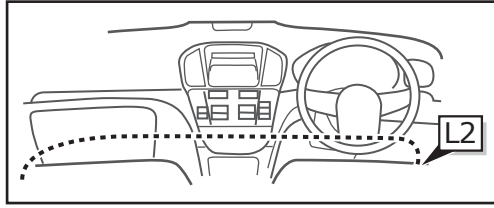
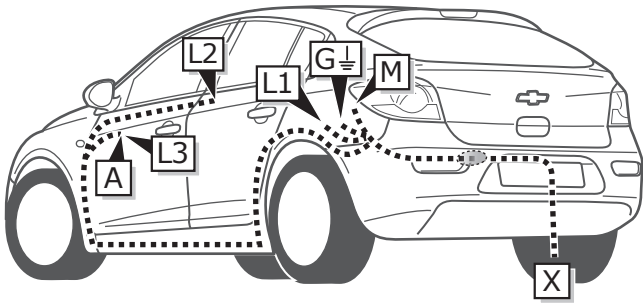

Cruze HB

Pag. 24

Pag. 26

1

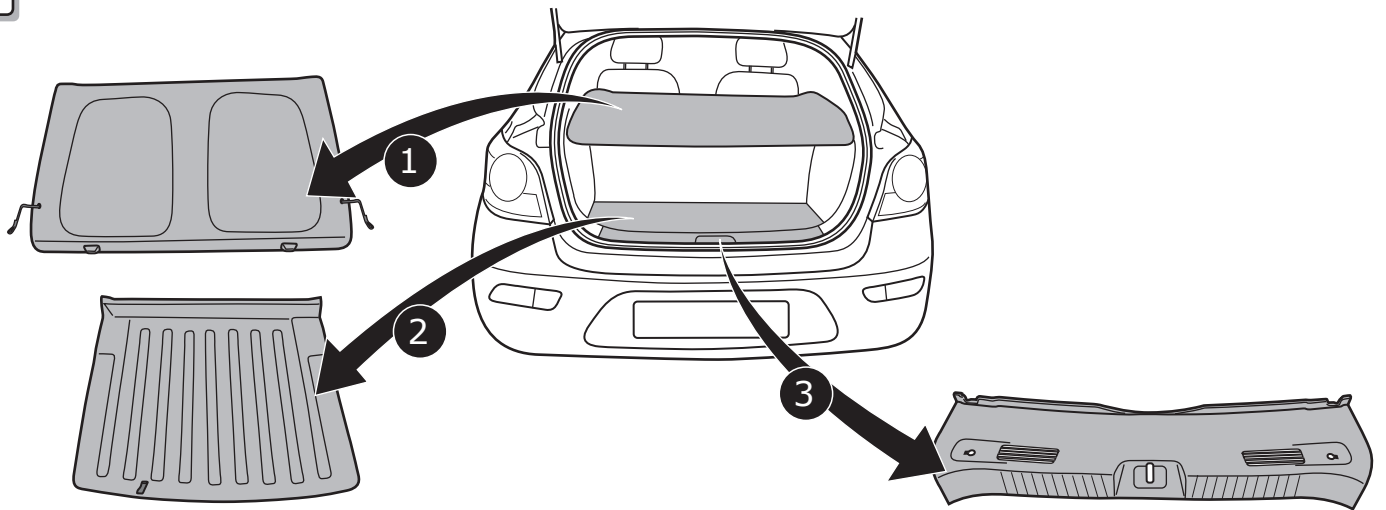

2

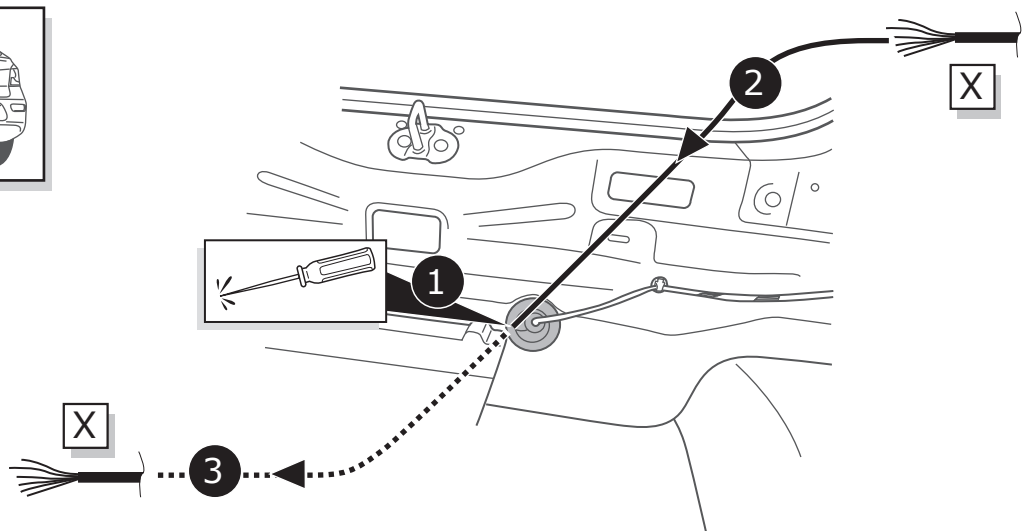
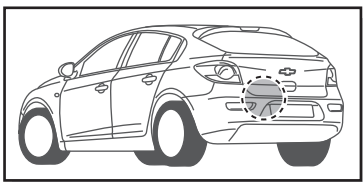

3



Pag. 34

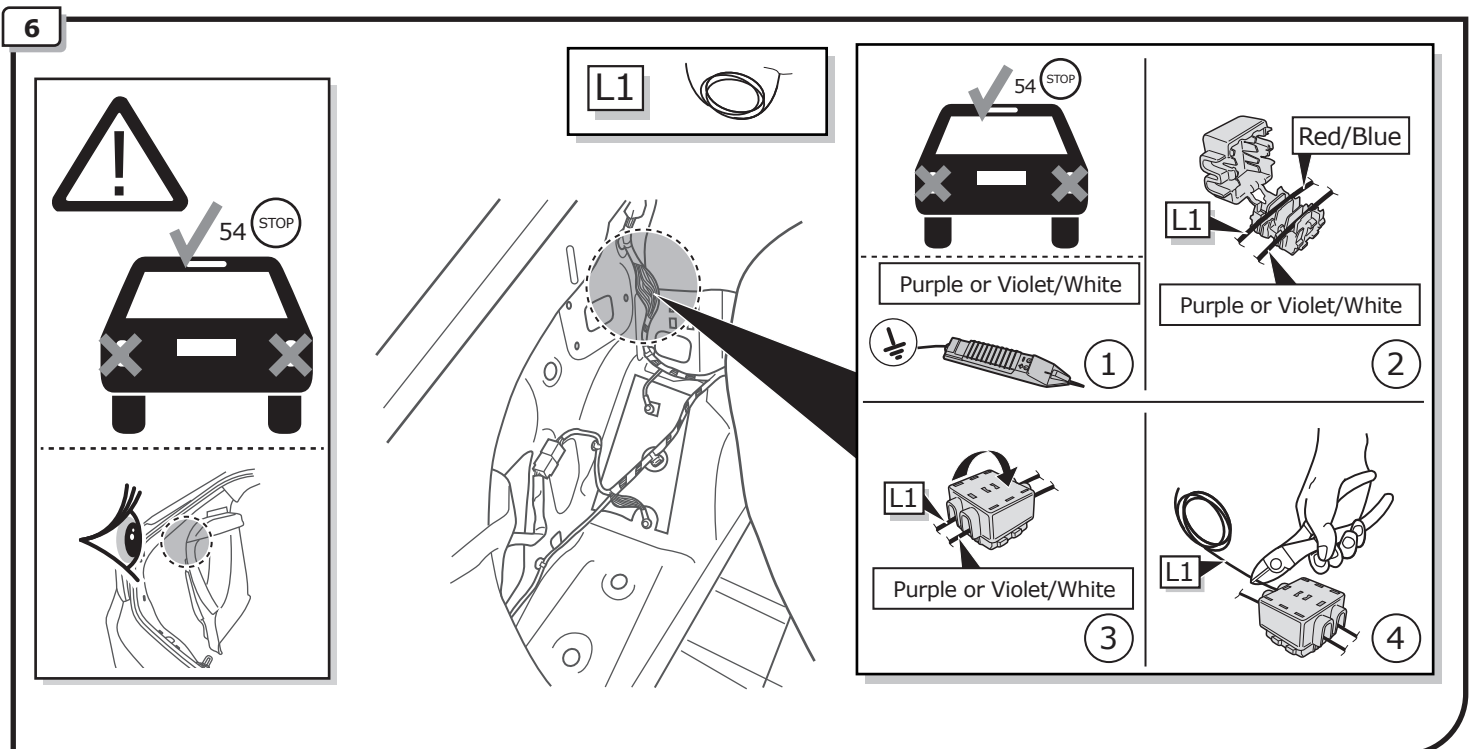
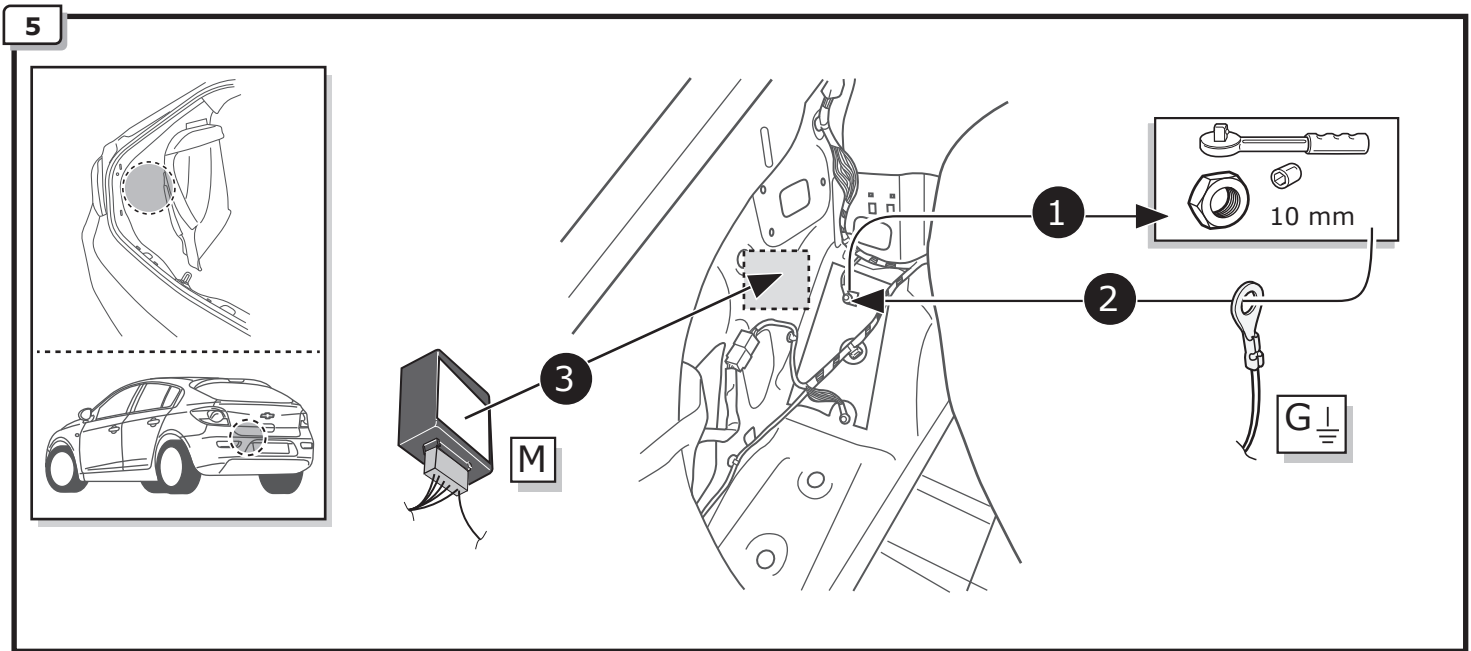
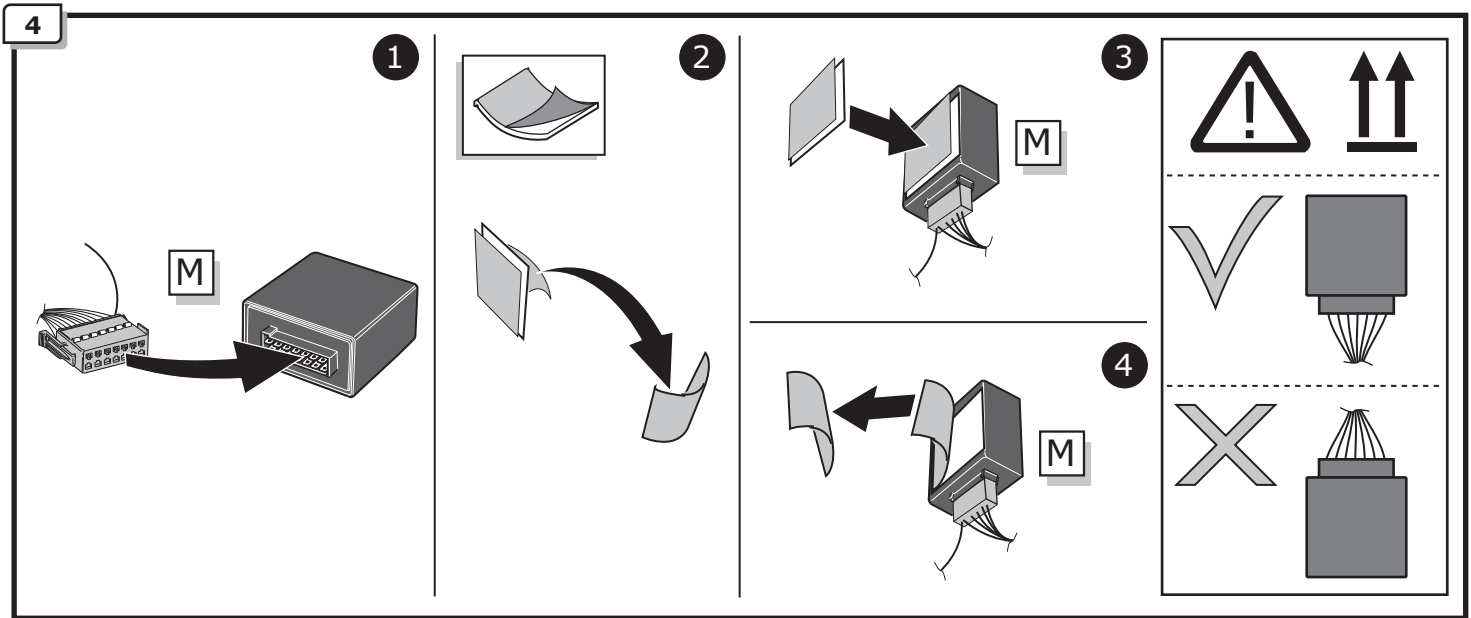

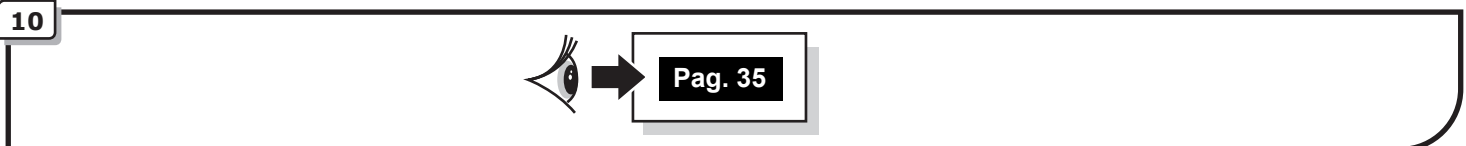
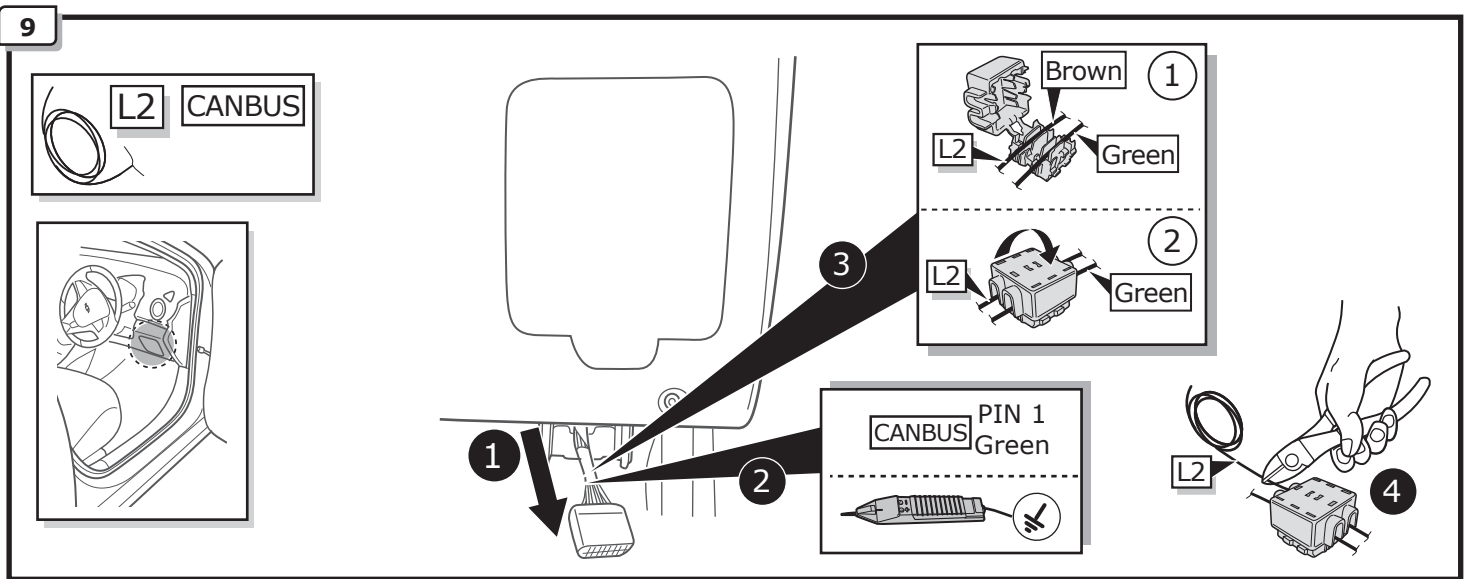
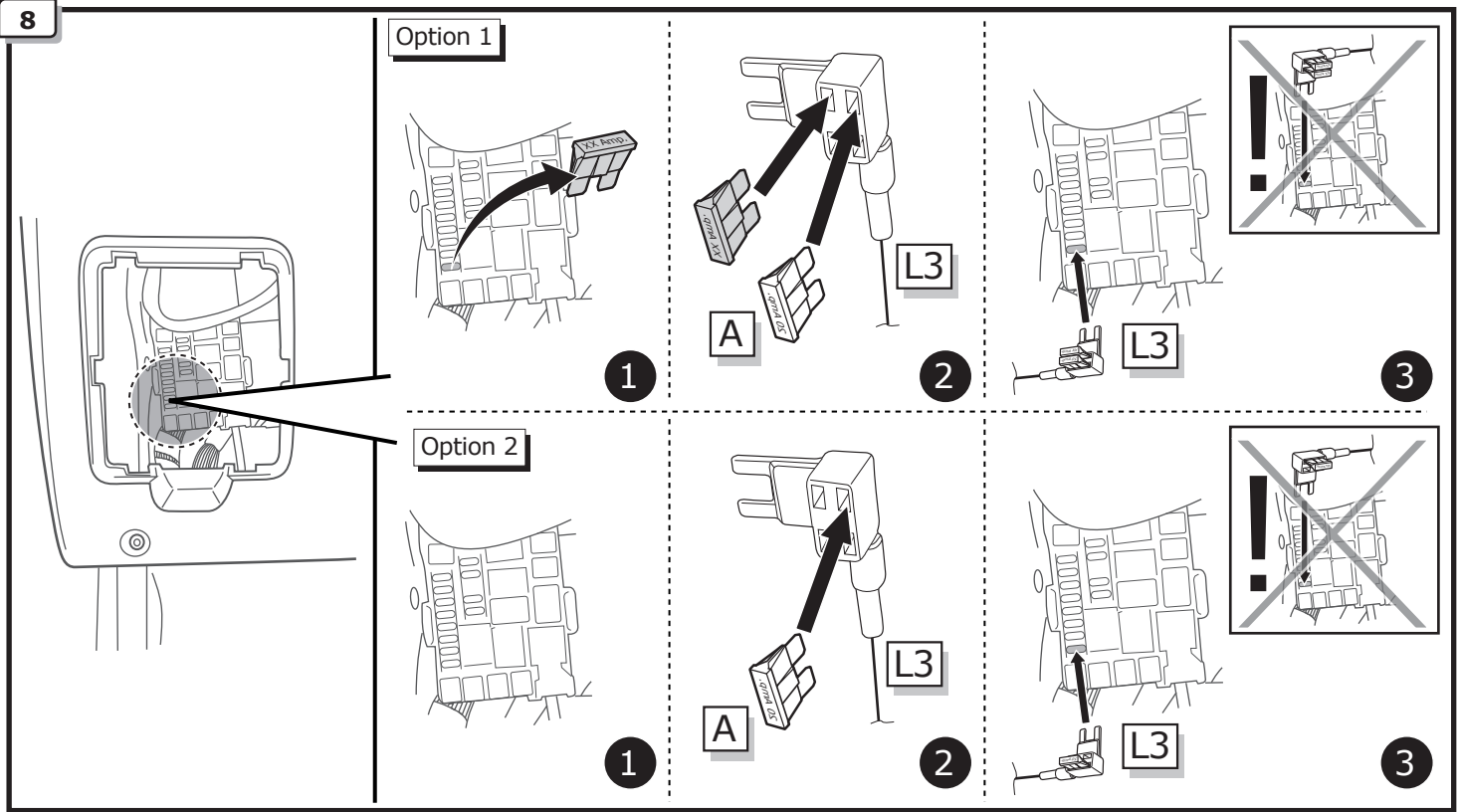
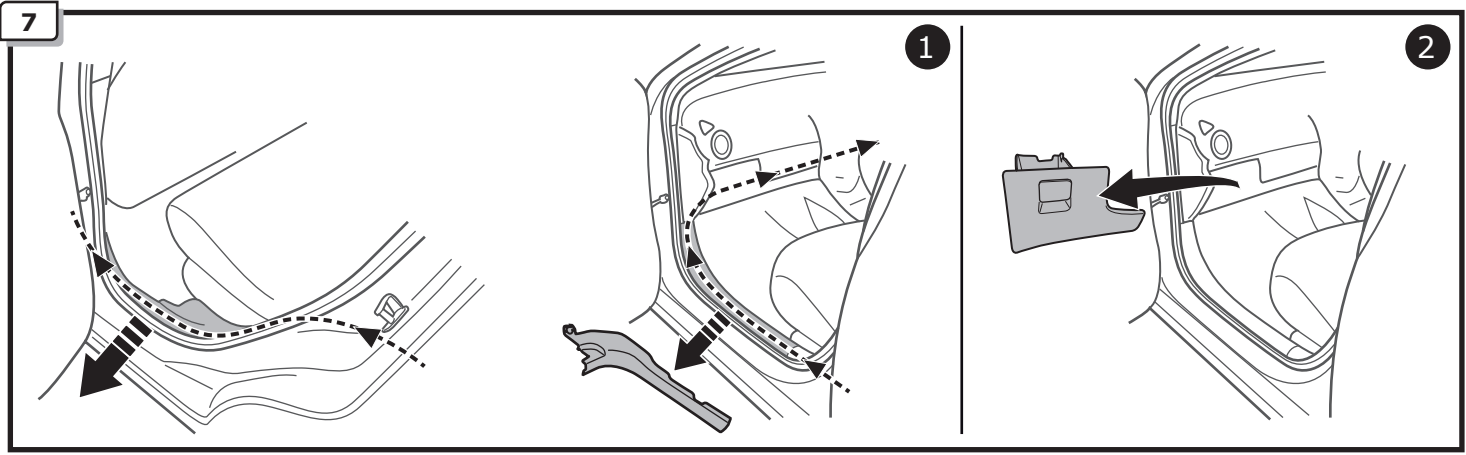

INFO

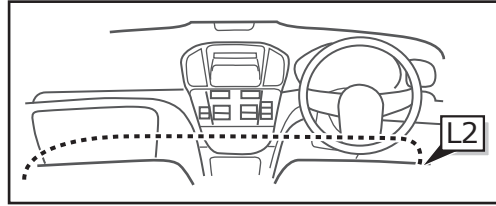
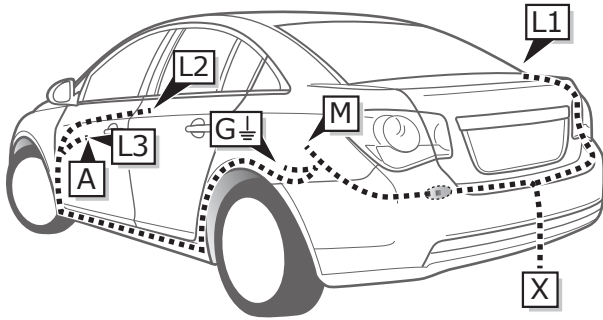

Cruze NB

Pag. 27

-
Pag. 30

1

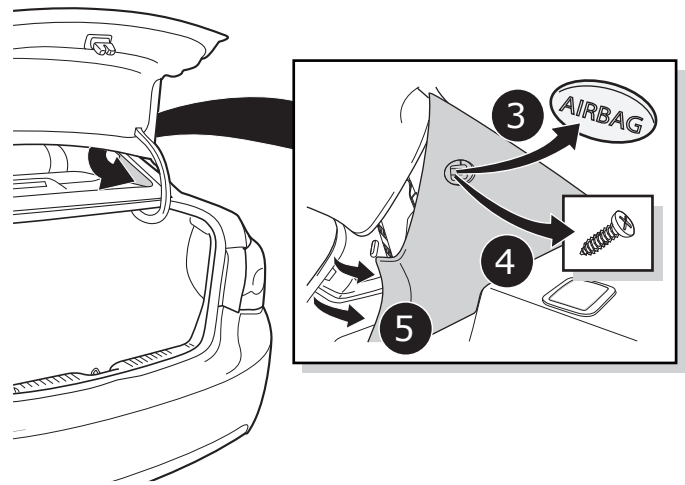
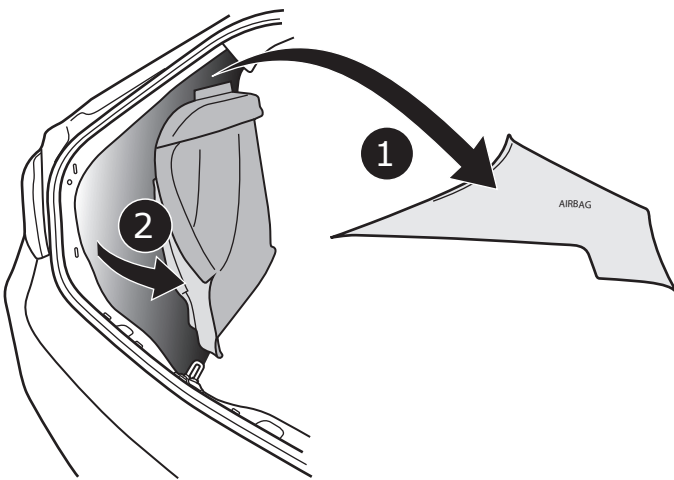

2

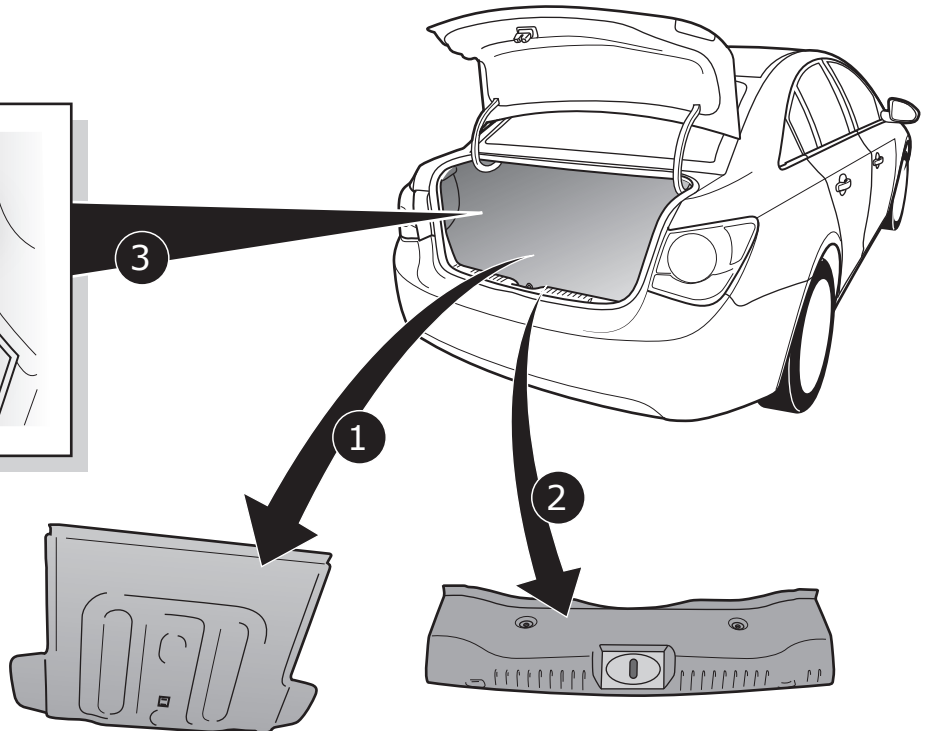
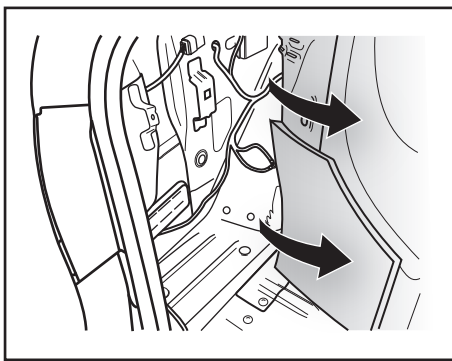

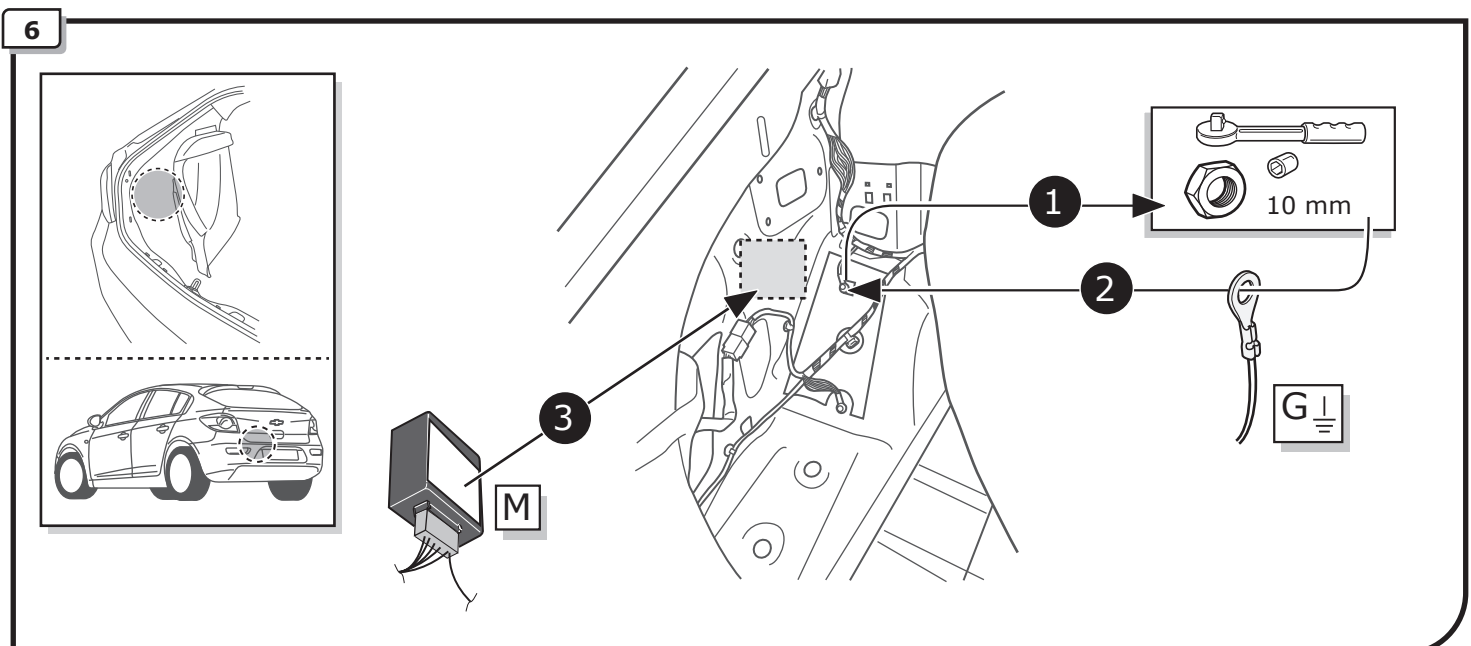
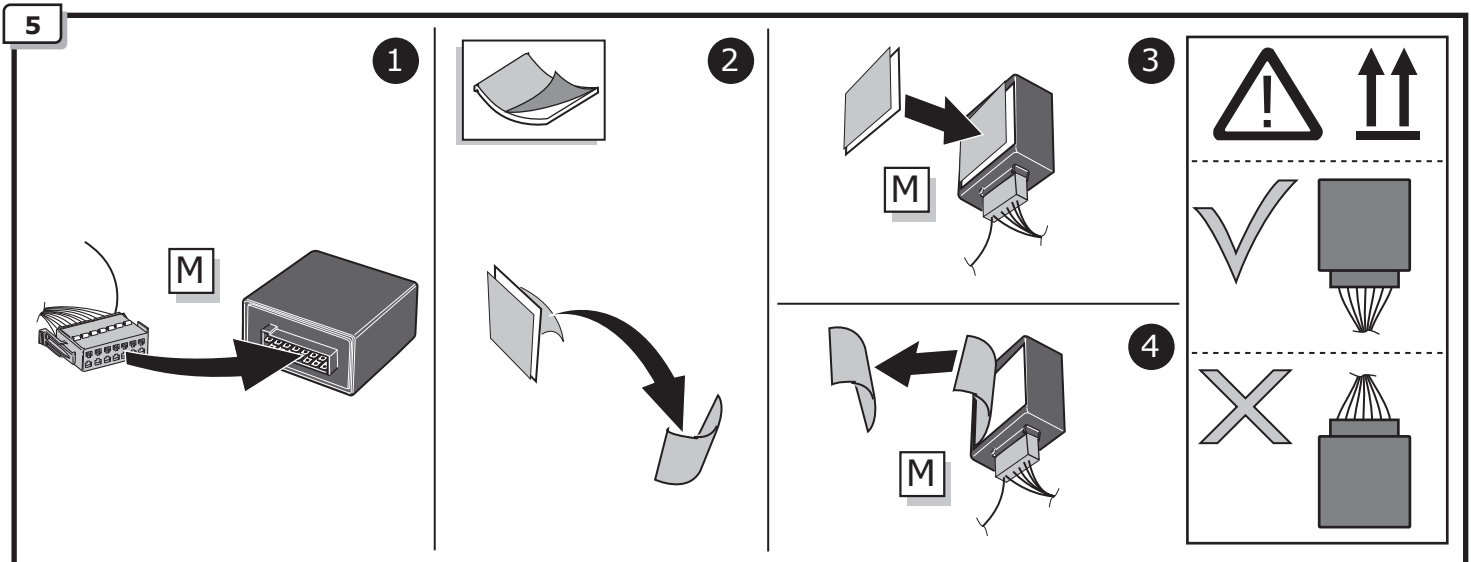
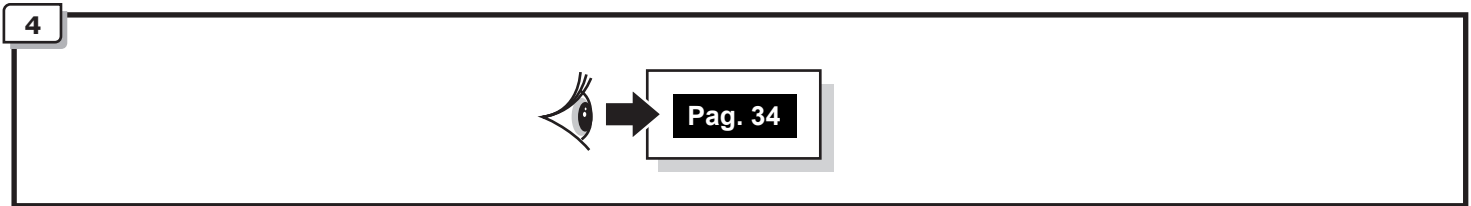
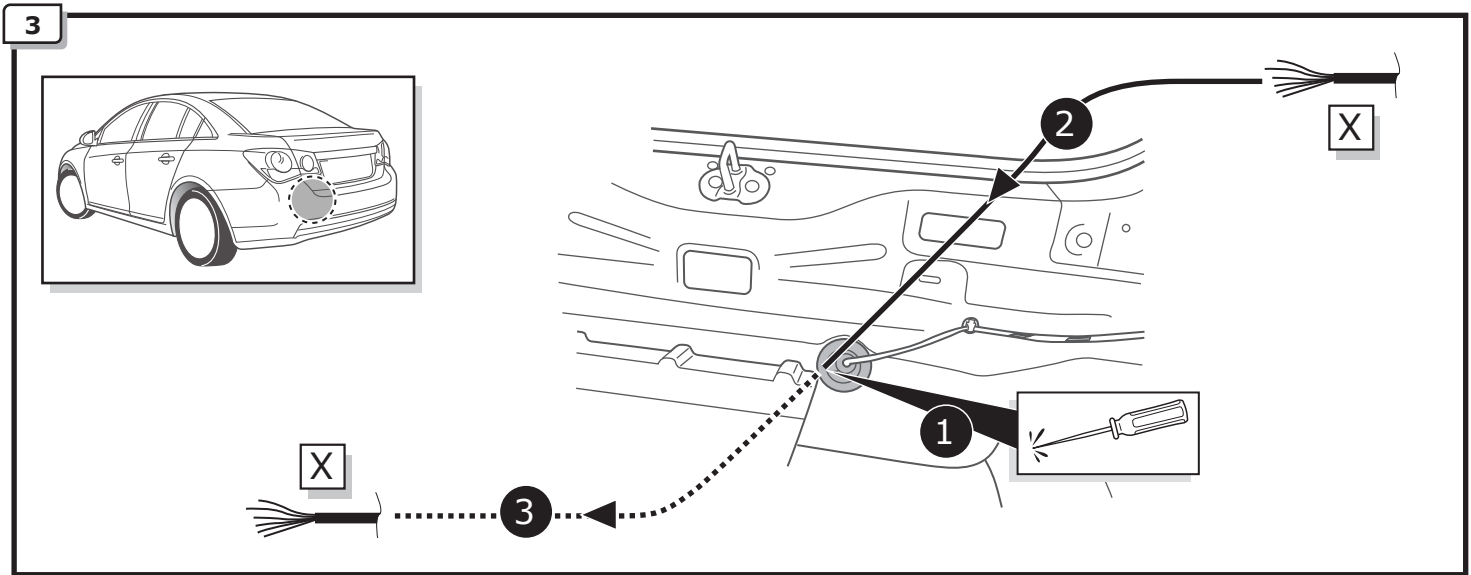

7

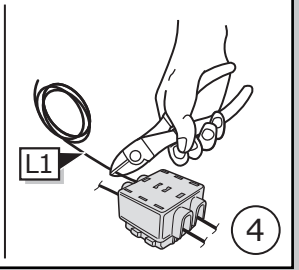
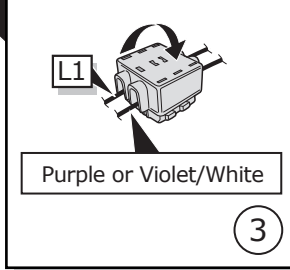
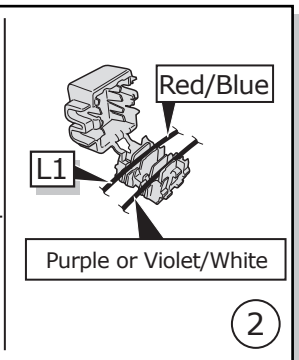
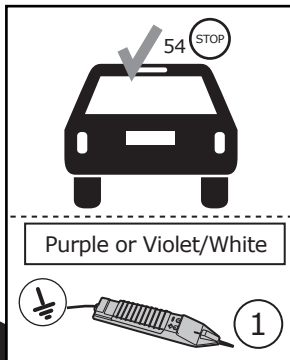
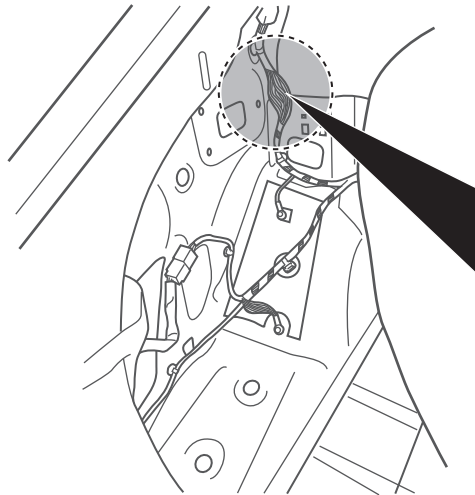
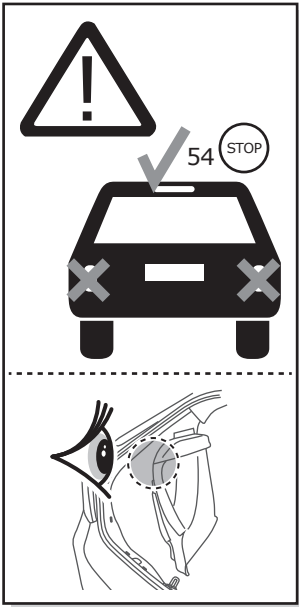

8

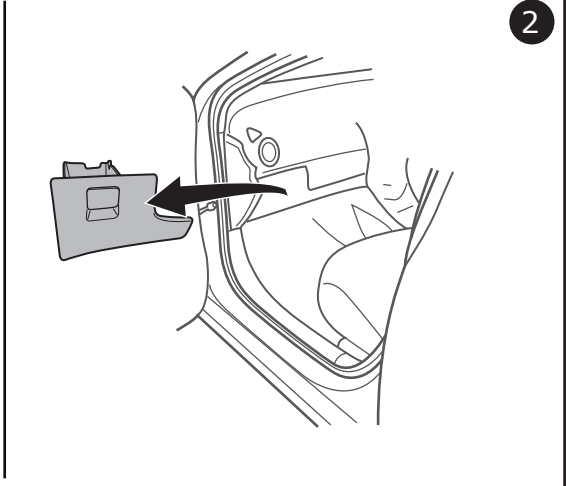
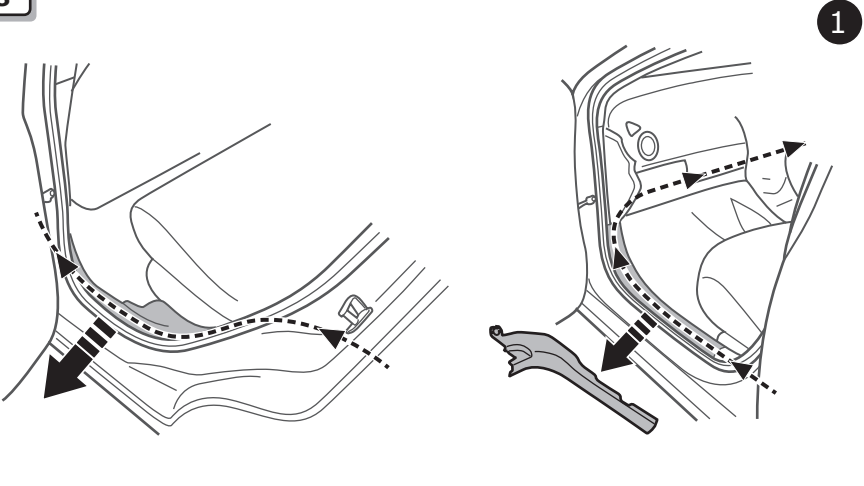

9

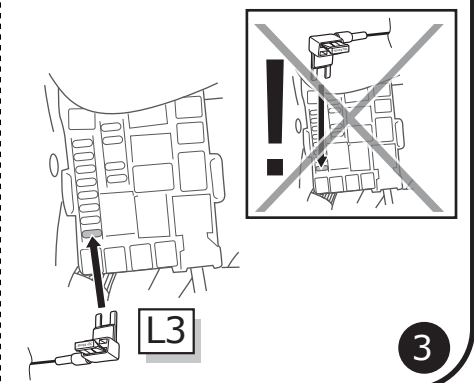
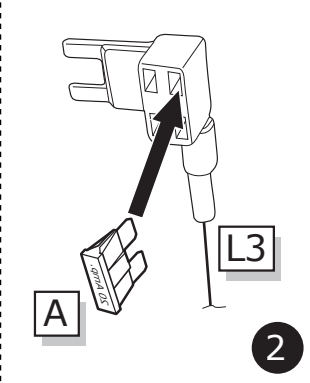
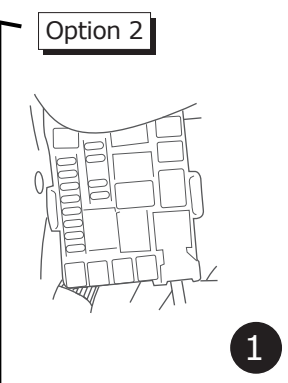
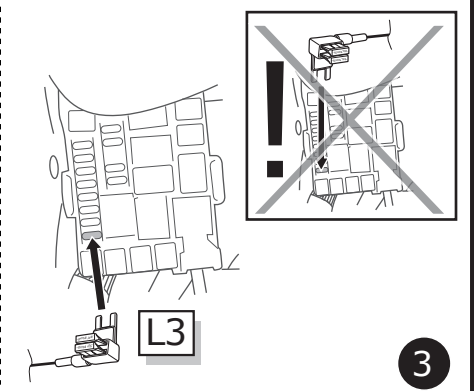
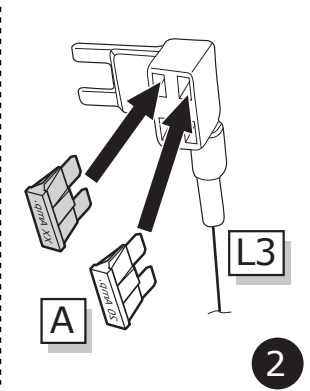
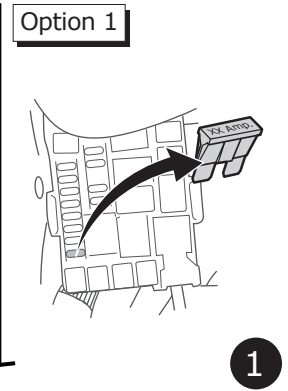
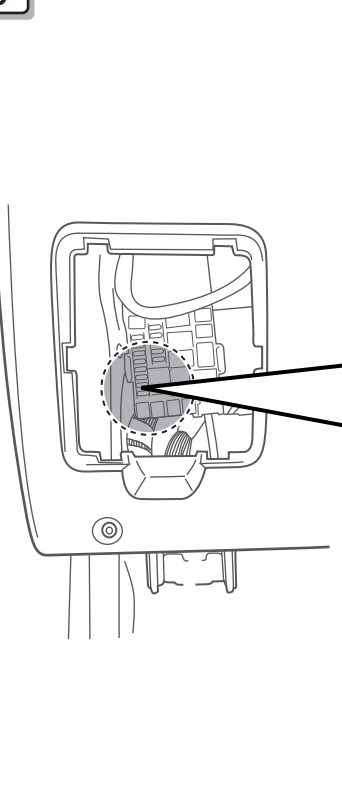

10

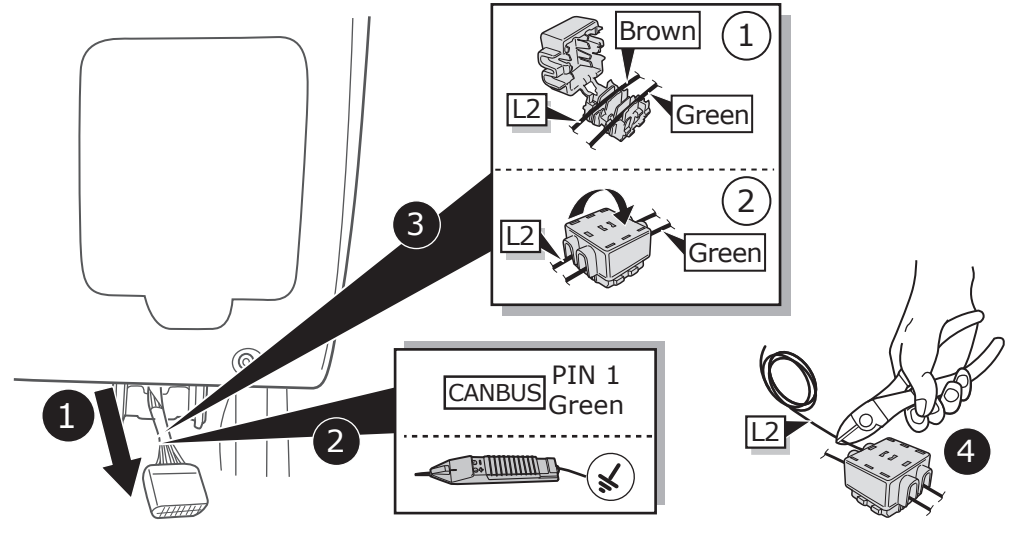
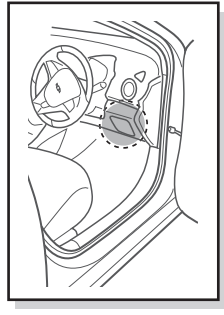
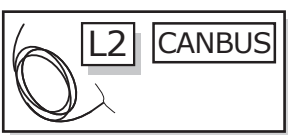

11



INFO

Cruze SW

Pag. 31

Pag. 33

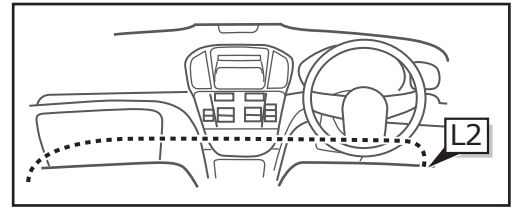
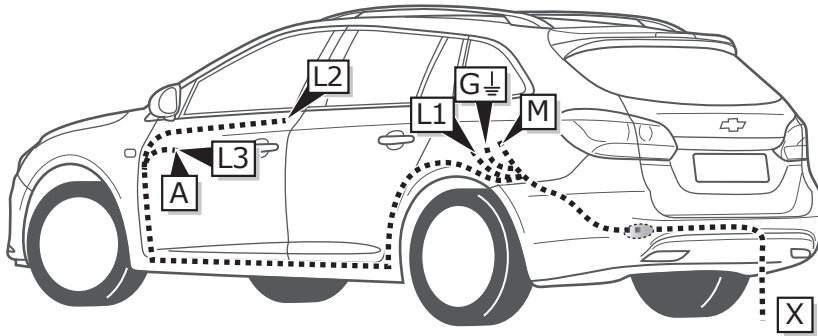

1

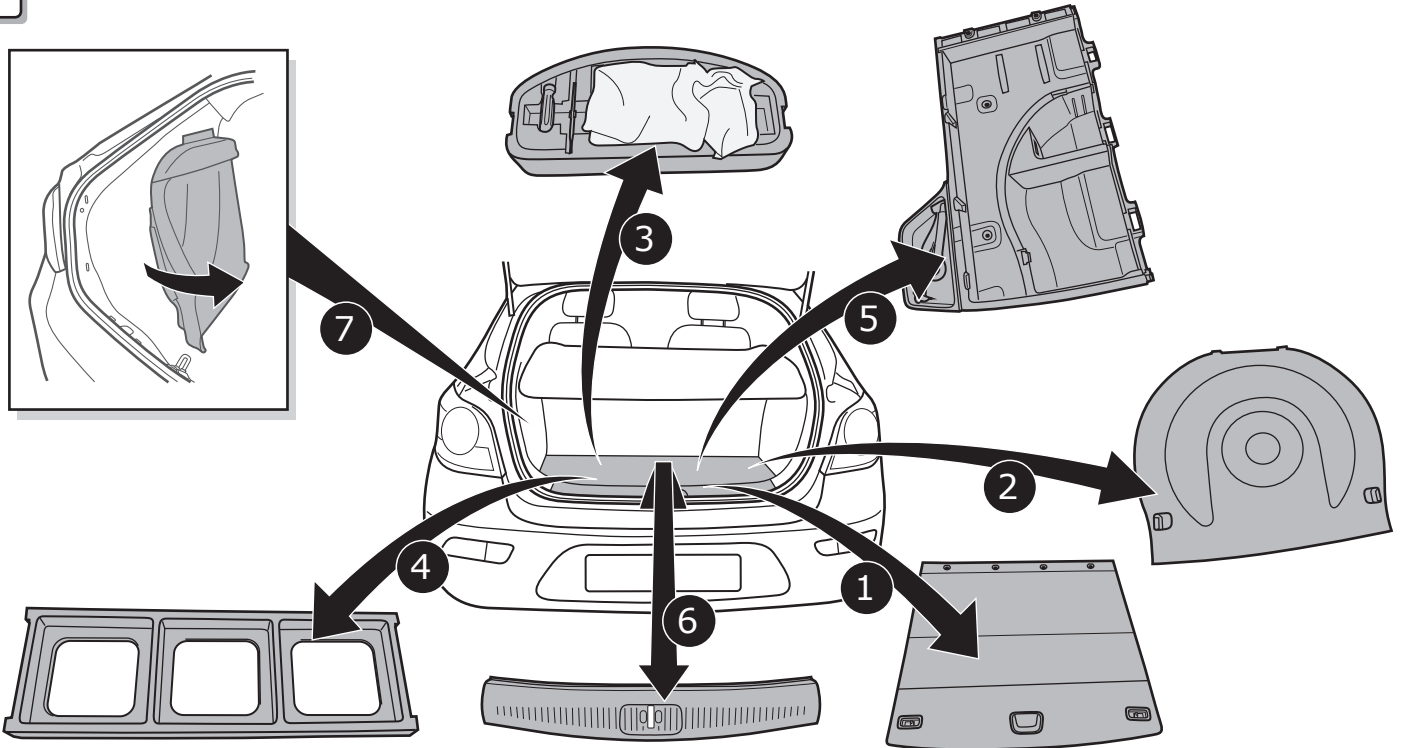

2

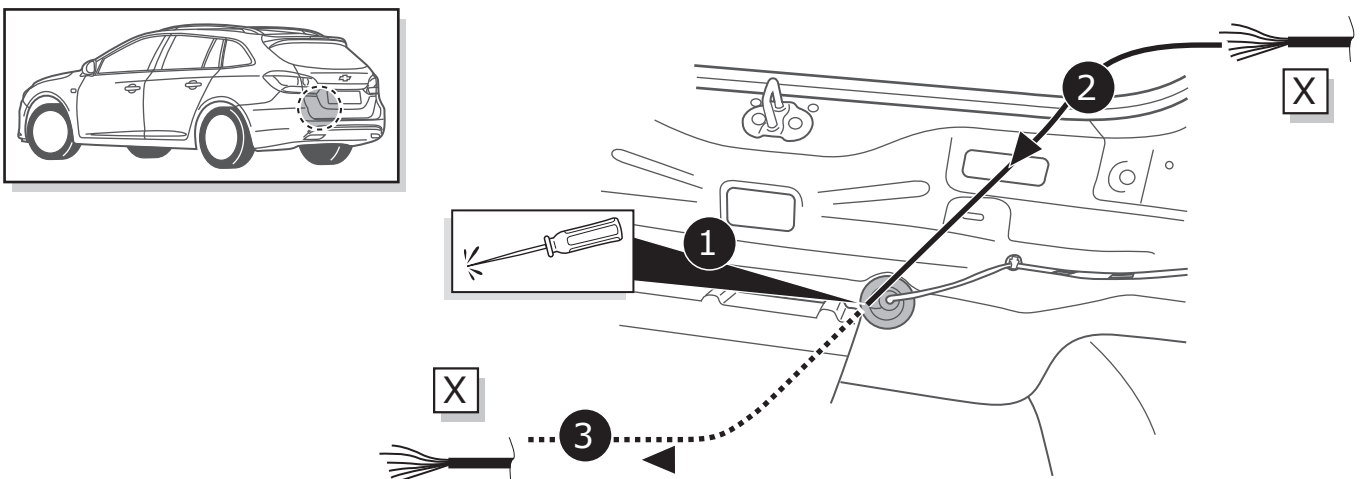

3



Pag. 34

4

1

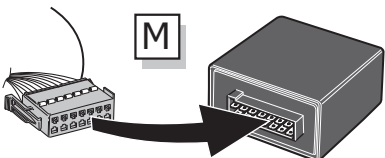

2

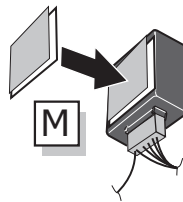
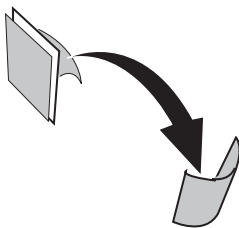

3

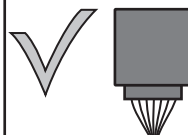

4

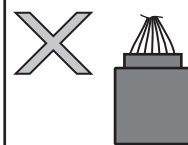

5

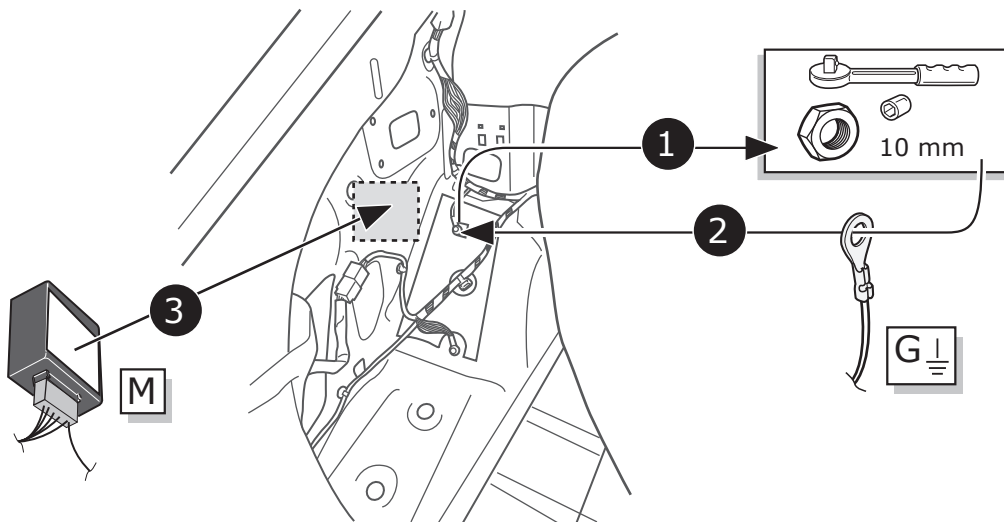
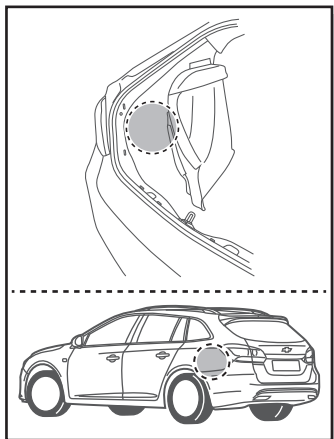

6

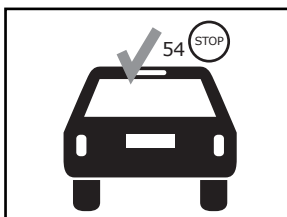
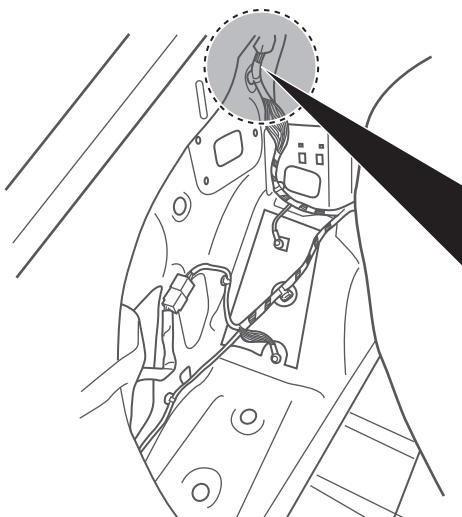
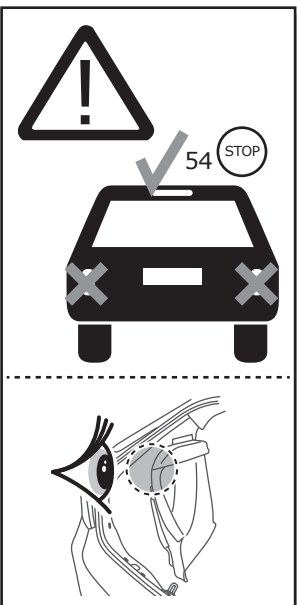

Purple or Violet/White

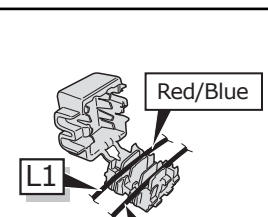
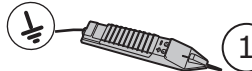

Purple or Violet/White

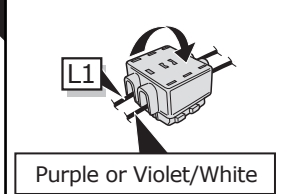

Purple or Violet/White

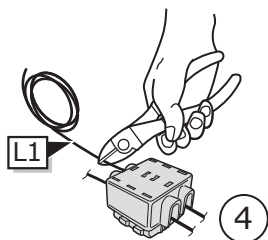

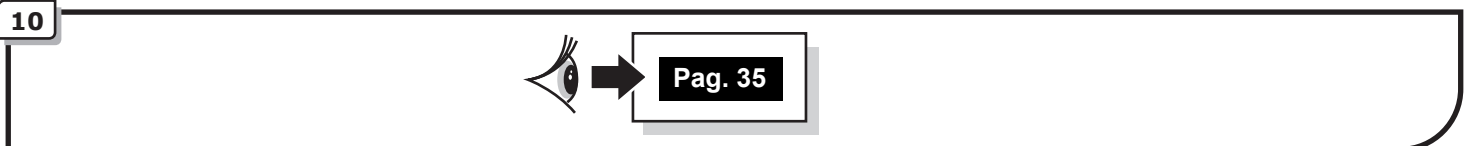
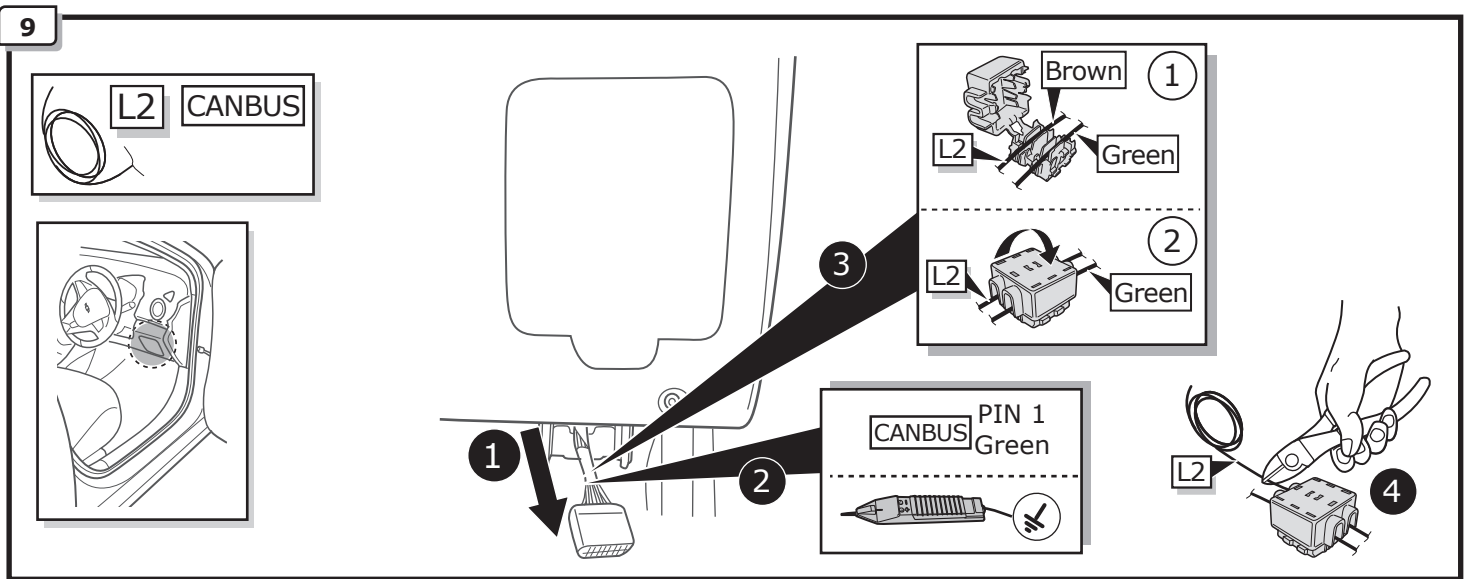
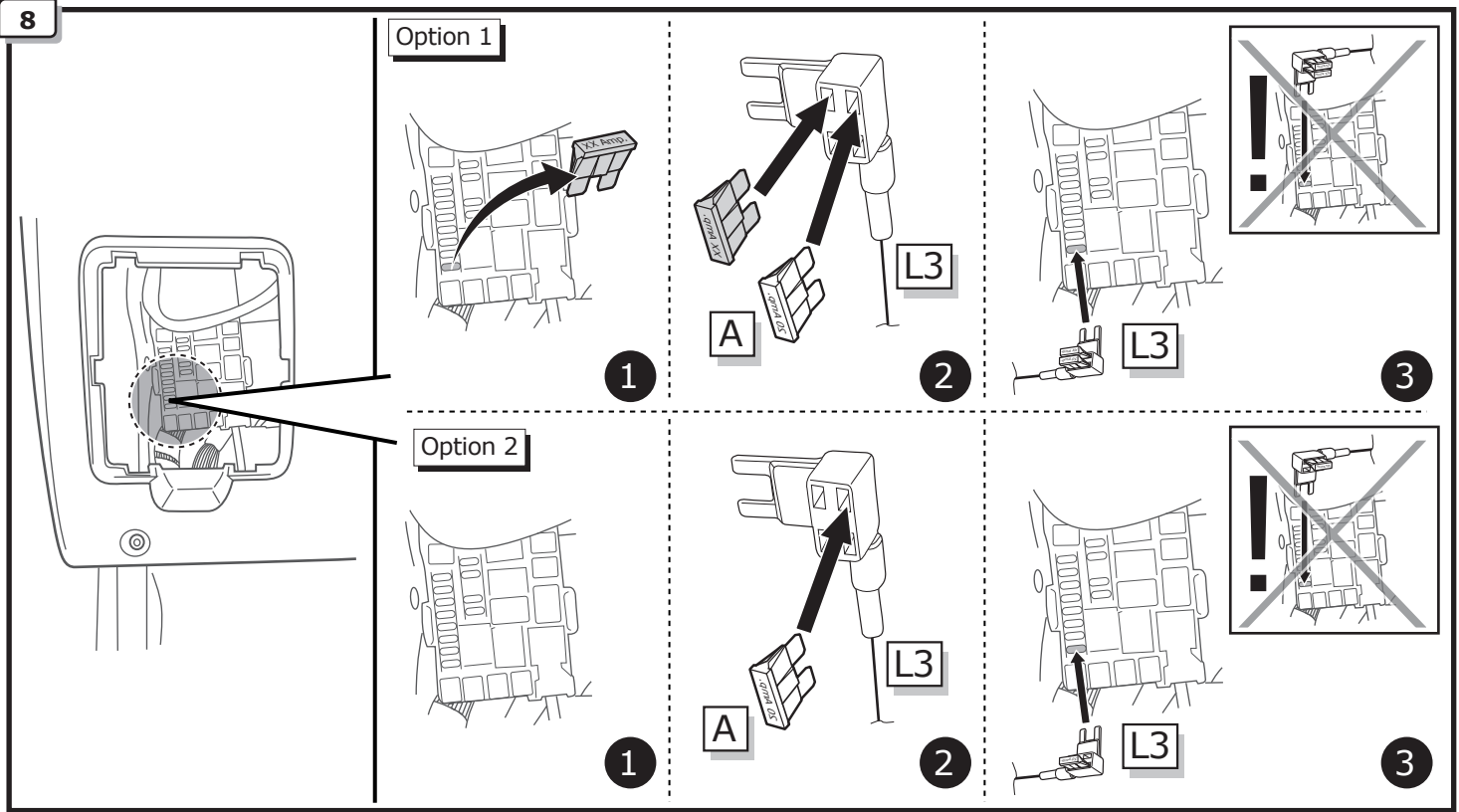
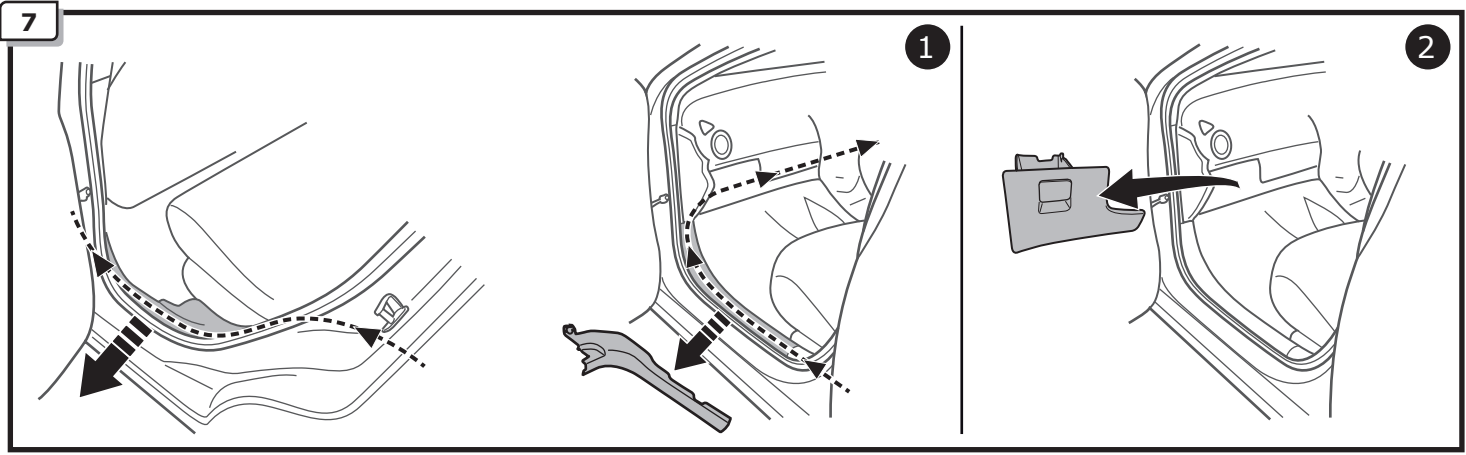

A

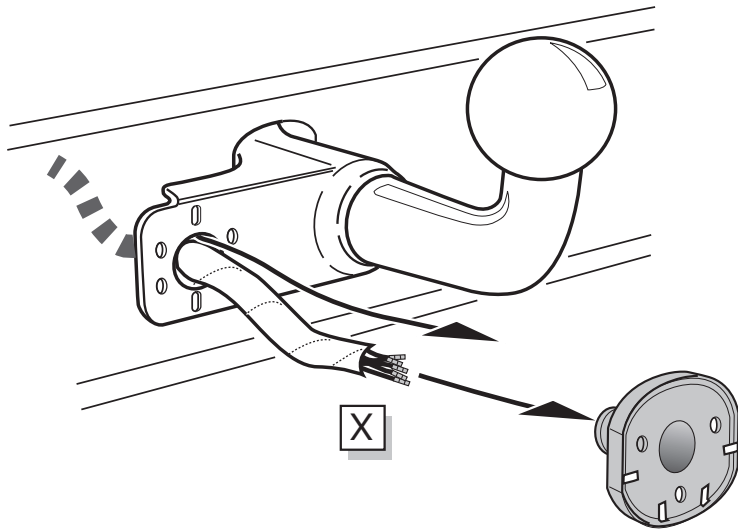

INFO

SOCKET CONNECTION 

Pag. 36

B

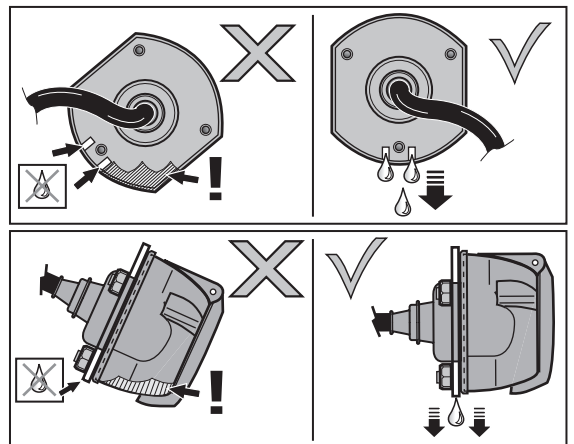
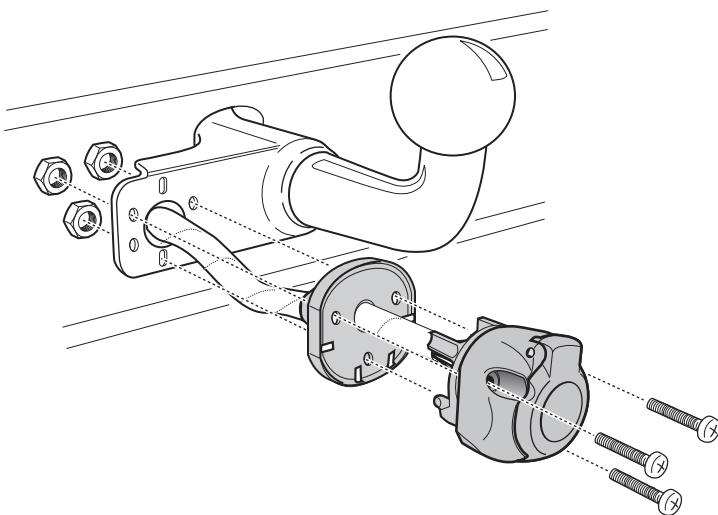

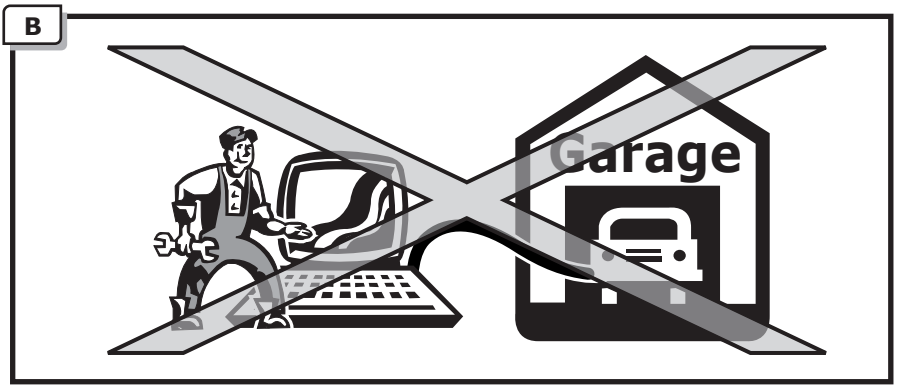
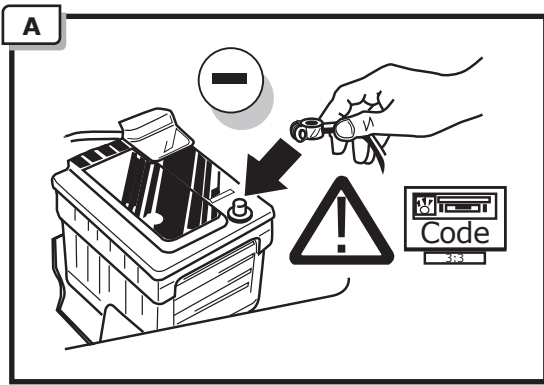

C

! TEST ALL THE CIRCUITS WITH A TEST DEVICE WITH THE CORRECT POWER LOAD FOR EACH FUNCTION. A TEST DEVICE WITH LED'S CANNOT BE USED FOR THIS PURPOSE.

D

REINSTALL TRIM.

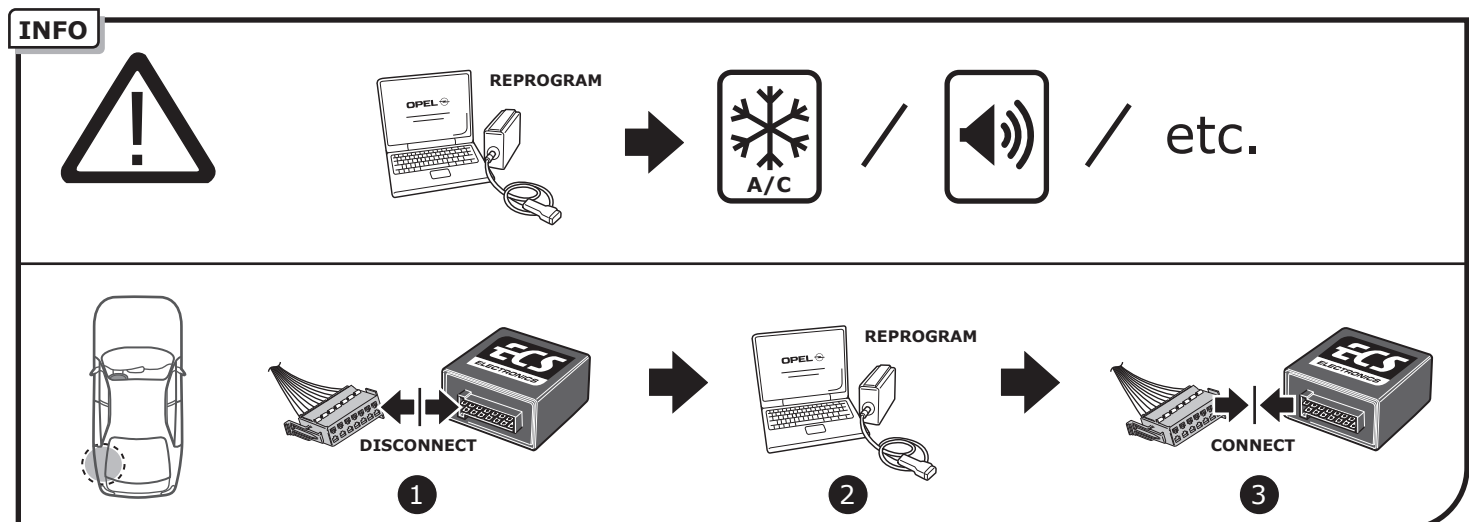
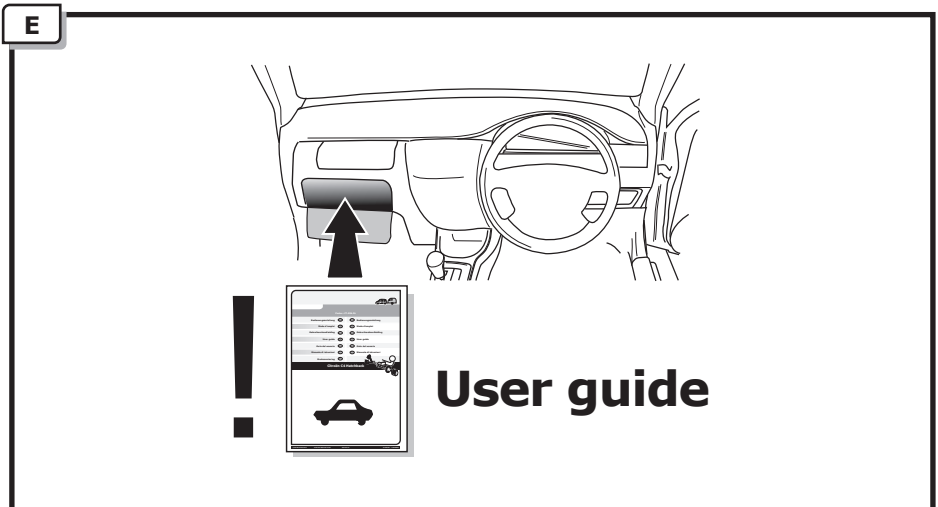

INFO

TECHNICAL SUPPORT

CALL 07440 202 052

ECS ELECTRONICS

MONDAY TO FRIDAY
08.00 - 11.00 am
12.00 - 05.00 pm
t.skinner@ecs-electronics.com
www.ecs-electronicsuk.co.uk

Products & Service

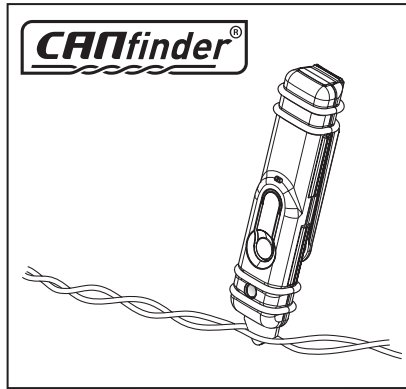

http://www.ecs-electronics.nl/NL/catalogus/test_gereedschap

INFO

SOCKET CONNECTION

| | | | | | | | |
|---------------------|--------|------|-------|-------|--------|-------|--------|
| DIN/ISO 1724 | | | | | | | |
| | 1/L | 2 | 3/31 | 4/R | 5/58-R | 6/54 | 7/58-L |
| Pmax | 21W | 21W | | 21W | 42W | 3x21W | 42W |
| Colour | Yellow | Blue | White | Green | Brown | Red | Black |

UN-243-YZ Reverse lamp pre-wire extension

⚠ MAX = 21W

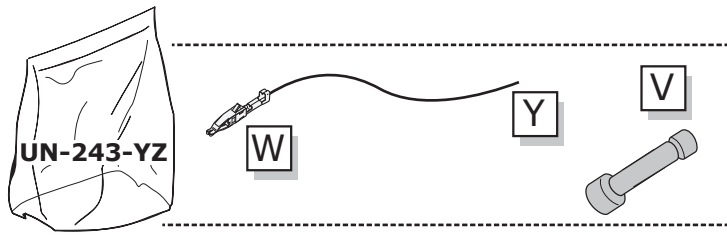

A

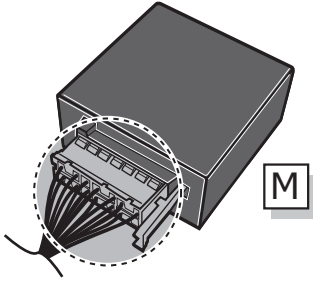

1

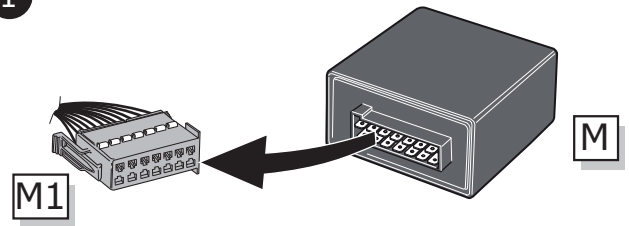

2

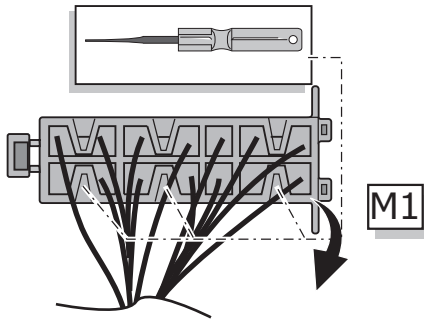

3

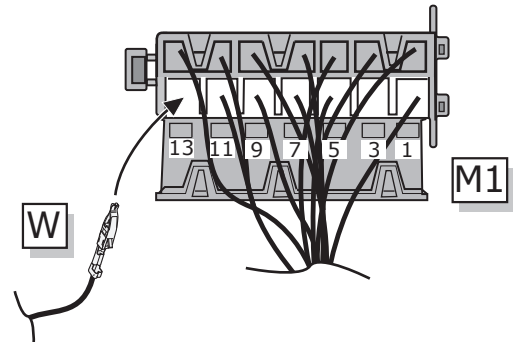

4

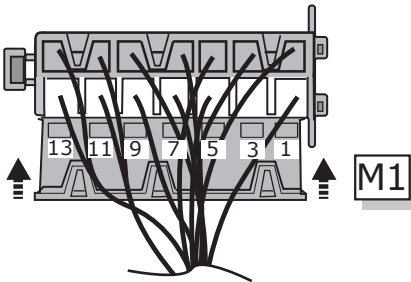

5

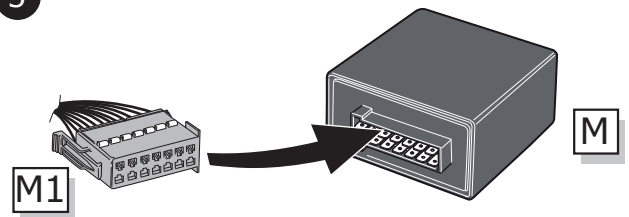

B

⚠ MAX = 21W

